

32MD359B LCD TV/DVD



Thank you for choosing
Magnavox.

Need help fast?

Read your User Manual first for quick tips that make using your Magnavox product more enjoyable. If you have read your instructions and still need assistance, you may access our online help at www.magnavox.com/support or call **1-866-341-3738** while with your product (and Model / Serial number)



Magnavox vous remercie de
votre confiance.

Besoin d'une aide rapide?

Manuel de l'utilisateur regorgent d'astuces destinées à simplifier l'utilisation de votre produit Magnavox. Toutefois, si vous ne parvenez pas à résoudre votre problème, vous pouvez accéder à notre aide en ligne à l'adresse www.magnavox.com/support ou formez le **1-866-341-3738** Veuillez à avoir votre produit à portée de main (et model / serial nombre)



Gracias por escoger Magnavox.

Necesita ayuda inmediata?

Lea primero el Manual del usuario, en donde encontrará consejos que le ayudarán a disfrutar plenamente de su producto Magnavox. Si después de leerlo aún necesita ayuda, consulte nuestro servicio de asistencia en línea en www.magnavox.com/support o llame al teléfono **1-866-341-3738** y tenga a mano el producto (y número de model / serial)



MODEL NUMBER

SERIAL NUMBER



English

Français

Español

Return your Product Registration Card or register online at
www.magnavox.com/support today to get the very most from your purchase.

Registering your model with MAGNAVOX makes you eligible for all of the valuable benefits listed below, so don't miss out. Complete and return your Product Registration Card at once, **or register online at www.magnavox.com/support** to ensure:

*Proof of Purchase

Returning the enclosed card guarantees that your date of purchase will be on file, so no additional paperwork will be required from you to obtain warranty service.

*Product Safety Notification

By registering your product, you'll receive notification directly from the manufacturer - in the rare case of a product recall or safety defect.

*Additional Benefits

Registering your product guarantees that you'll receive all of the privileges to which you're entitled, including special money-saving offers.

MAGNAVOX

Congratulations on your purchase, and welcome to the "family!"

Dear MAGNAVOX product owner:

Thank you for your confidence in MAGNAVOX. You've selected one of the best-built, best-backed products available today. We'll do everything in our power to keep you happy with your purchase for many years to come.

As a member of the MAGNAVOX "family," you're entitled to protection by one of the most comprehensive warranties and outstanding service networks in the industry. What's more, your purchase guarantees you'll receive all the information and special offers for which you qualify, plus easy access to accessories from our convenient home shopping network.

Most importantly, you can count on our uncompromising commitment to your total satisfaction.

All of this is our way of saying welcome - and thanks for investing in a MAGNAVOX product.

P.S. To get the most from your MAGNAVOX purchase, be sure to complete and return your Product Registration Card at once or register online at:

www.magnavox.com/support

Know these **safety** symbols



 This "bolt of lightning" indicates uninsulated material within your unit may cause an electrical shock. For the safety of everyone in your household, please do not remove product covering.

 The "exclamation point" calls attention to features for which you should read the enclosed literature closely to prevent operating and maintenance problems.

WARNING : To reduce the risk of fire or electric shock, this apparatus should not be exposed to rain or moisture and objects filled with liquids, such as vases, should not be placed on this apparatus.

CAUTION : To prevent electric shock, match wide blade of plug to wide slot, fully insert.

ATTENTION : Pour éviter les choc électriques, introduire la lame la plus large de la fiche dans la borne correspondante de la prise et pousser jusqu'au fond.

For Customer Use

Enter below the Serial No. which is located on the rear of the cabinet. Retain this information for future reference.

Model No. _____

Serial No. _____

IMPORTANT SAFETY INSTRUCTIONS

Read before operating equipment

1. Read these instructions.
2. Keep these instructions.
3. Heed all warnings.
4. Follow all instructions.
5. Do not use this apparatus near water.
6. Clean only with a dry cloth.
7. Do not block any of the ventilation openings.
Install in accordance with the manufacturers instructions.
8. Do not install near any heat sources such as radiators, heat registers, stoves, or other apparatus (including amplifiers) that produce heat.
9. Do not defeat the safety purpose of the polarized or grounding-type plug. A polarized plug has two blades with one wider than the other. A grounding type plug has two blades and third grounding prong. The wide blade or third prong are provided for your safety. When the provided plug does not fit into your outlet, consult an electrician for replacement of the obsolete outlet.
10. Protect the power cord from being walked on or pinched particularly at plugs, convenience receptacles, and the point where they exit from the apparatus.
11. Only use attachments/accessories specified by the manufacturer.
12.  Use only with a cart, stand, tripod, bracket, or table specified by the manufacturer, or sold with the apparatus. When a cart is used, use caution when moving the cart/apparatus combination to avoid injury from tip-over.
13. Unplug this apparatus during lightning storms or when unused for long periods of time.
14. Refer all servicing to qualified service personnel. Servicing is required when the apparatus has been damaged in any way, such as power-supply cord or plug is damaged, liquid has been spilled or objects have fallen into apparatus, the apparatus has been exposed to rain or moisture, does not operate normally, or has been dropped.
15. **Damage Requiring Service** - The appliance should be serviced by qualified service personnel when:
 - A. The power supply cord or the plug has been damaged;
 - B. Objects have fallen, or liquid has been spilled into the appliance;
 - C. The appliance has been exposed to rain
 - D. The appliance does not appear to operate normally or exhibits a marked change in performance;
 - E. The appliance has been dropped, or the enclosure damaged.
16. **Tilt/Stability** - All televisions must comply with recommended international global safety standards for tilt and stability properties of its cabinet design.
 - Do not compromise these design standards by applying excessive pull force to the front, or top, of the cabinet which could ultimately overturn the product.
 - Also, do not endanger yourself, or children, by placing electronic equipment/toys on the top of the cabinet. Such items could unsuspectingly fall from the top of the set and cause product damage and/or personal injury.
17. **Wall or Ceiling Mounting** - The appliance should be mounted to a wall or ceiling only as recommended by the manufacturer.
18. **Power Lines** - An outdoor antenna should be located away from power lines.
19. **Outdoor Antenna Grounding** - If an outside antenna is connected to the receiver, be sure the antenna system is grounded so as to provide some protection against voltage surges and built up static charges. Section 810 of the National Electric Code, ANSI/NFPA No. 70-1984, provides information with respect to proper grounding of the mast and supporting structure, grounding of the lead-in wire to an antenna discharge unit, size of grounding connectors, location of antenna-discharge unit, connection to grounding electrodes, and requirements for the grounding electrode. See Figure below.
20. **Object and Liquid Entry** - Care should be taken so that objects do not fall and liquids are not spilled into the enclosure through openings.
21. **Battery Usage CAUTION** - To prevent battery leakage that may result in bodily injury, property damage, or damage to the unit:
 - Install all batteries correctly, with + and - aligned as marked on the unit.
 - Do not mix batteries (old and new or carbon and alkaline, etc.).
 - Remove batteries when the unit is not used for a long time.

Note to the CATV system installer : This reminder is provided to call the CATV system installer's attention to Article 820-40 of the NEC that provides guidelines for proper grounding and, in particular, specifies that the cable ground shall be connected to the grounding system of the building, as close to the point of cable entry as practical.

Example of Antenna Grounding as per NEC - National Electric Code

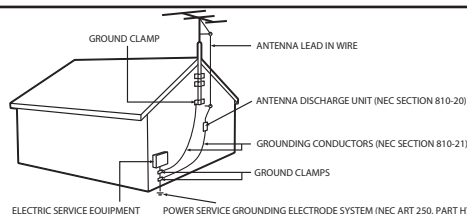

✓ **Precaution**

Do not place the unit on the furniture that is capable of being tilted by a child and an adult leaning, pulling, standing or climbing on it. A falling unit can cause serious injury or even death.

FCC WARNING

This apparatus may generate or use radio frequency energy. Changes or modifications to this apparatus may cause harmful interference unless the modifications are expressly approved in the manual. The user could lose the authority to operate this apparatus if an unauthorized change or modification is made.

RADIO-TV INTERFERENCE

This apparatus has been tested and found to comply with the limits for a Class B digital device, pursuant to Part 15 of the FCC Rules. These limits are designed to provide reasonable protection against harmful interference in a residential installation. This apparatus generates, uses, and can radiate radio frequency energy and, if not installed and used in accordance with the instructions, may cause harmful interference to radio communications. However, there is no guarantee that interference will not occur in a particular installation. If this apparatus does cause harmful interference to radio or television reception, which can be determined by turning the apparatus off and on, the user is encouraged to try to correct the interference by one or more of the following measures:

- 1) Reorient or relocate the receiving antenna.
- 2) Increase the separation between the apparatus and receiver.
- 3) Connect the apparatus into an outlet on a circuit different from that to which the receiver is connected.
- 4) Consult the dealer or an experienced radio/TV technician for help.

This Class B digital apparatus complies with Canadian ICES-003.

This apparatus should not be placed in a built-in installation such as a bookcase or rack unless proper ventilation is provided. Make sure to leave a space of 3.2 inches (8cm) or more around this apparatus.

Disconnect the mains plug to shut off when find trouble or not in use. The mains plug shall remain readily operable.

CAUTION: Danger of explosion if battery is incorrectly replaced. Replace only with the same or equivalent type.

WARNING: Batteries (battery pack or battery installed) shall not be exposed to excessive heat such as sunshine, fire or the like.



Like all LCD products, this set contains a lamp with Mercury, please dispose of according to all Local, State and Federal laws. For the disposal or recycling information, contact: www.mygreenelectronics.com or www.eiae.org

WARNING: To prevent injury, this apparatus must be securely attached to the floor/wall in accordance with the instructions.

LASER SAFETY

This unit employs a laser. Only a qualified service person should remove the cover or attempt to service this device, due to possible eye injury.

CAUTION: USE OF CONTROLS OR ADJUSTMENTS OR PERFORMANCE OF PROCEDURES OTHER THAN THOSE SPECIFIED HEREIN MAY RESULT IN HAZARDOUS RADIATION EXPOSURE.

CAUTION: VISIBLE AND INVISIBLE LASER RADIATION WHEN OPEN AND INTERLOCK DEFEATED. DO NOT STARE INTO BEAM.

LOCATION: INSIDE, NEAR THE DECK MECHANISM.

IMPORTANT COPYRIGHT INFORMATION

Unauthorized copying, broadcasting, public performance and lending of discs are prohibited. This product incorporates copyright protection technology that is protected by U.S. patents and other intellectual property rights. Use of this copyright protection technology must be authorized by Macrovision, and is intended for home and other limited viewing uses only unless otherwise authorized by Macrovision. Reverse engineering or disassembly is prohibited.

TO AVOID THE HAZARDS OF ELECTRICAL SHOCK AND FIRE

- Do not handle the AC power cord with wet hands.
- Do not remove this unit cabinet. Touching parts inside the cabinet could result in electric shock and/or damage to this unit. For service and adjustment inside the cabinet, call a qualified dealer or an authorized service center.
- Do not pull on the AC power cord when disconnecting it from an AC outlet. Grasp it by the plug.
- Do not put your fingers or objects into the unit.

LOCATION AND HANDLING

- The openings should not be blocked by placing the unit on a bed, sofa, carpet, rug, or other similar surface.
- Do not install the unit near or over a radiator or heat register.
- Do not install the unit in direct sunlight, near strong magnetic fields, or in a place subject to dust or strong vibration.
- Avoid a place with drastic temperature changes.
- Install the unit in a horizontal and stable position. Do not place anything directly on top or bottom of the unit. Depending on your external devices, noise or disturbance of the picture and/or sound may be generated if the unit is placed too close to them. In this case, please ensure enough space between the external devices and the unit.
- Depending on the environment, the temperature of this unit may increase slightly. This is not a malfunction.

DEW CONDENSATION WARNING

- Dew condensation may form inside the unit in the following conditions. If so, do not use this unit at least for a few hours until its inside gets dry.
 - The unit is moved from a cold place to a warm place.
 - Under conditions of high humidity.
 - After heating a cold room.

NOTE ABOUT RECYCLING

- This unit's packaging materials are recyclable and can be reused. Please dispose of any materials in accordance with your local recycling regulations.
- Batteries should never be thrown away or incinerated but disposed of in accordance with your local regulations concerning chemical wastes.



WHEN CARRYING THIS UNIT

- At least two people are required when carrying this unit.
- Make sure to hold the upper and bottom frames of the TV firmly as illustrated.

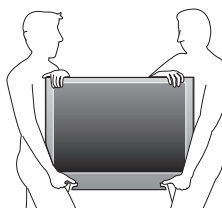

✓ Trademark Information

- HDMI, the HDMI logo and High-Definition Multimedia Interface are trademarks or registered trademarks of HDMI Licensing LLC.
- Manufactured under license from Dolby Laboratories. "Dolby" and the double-D symbol are trademarks of Dolby Laboratories.
- Products that have earned ENERGY STAR® are designed to protect the environment through superior energy efficiency.
- **DVD** is a trademark of DVD Format/Logo Licensing Corporation.

✓ Symbols Used in this Manual

The following is the description for the symbols used in this manual. Description refers to:

TV FUNCTIONS	DVD FUNCTIONS
<p>TV : Analog TV operation</p> <p>DTV : Digital TV operation</p> <p>• If neither symbol appears under the function heading, operation is applicable to both.</p>	<p>DVD : Playback of DVD-video</p> <p>CD : Playback of audio CD</p> <p>• If neither of symbol appears under the function heading, operation is applicable to both.</p>

✓ Supplied Accessories

user manual
(1EMN24199)



quick start guide
(1EMN24379)

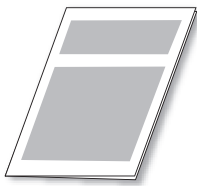

remote control
(NF801UD)



batteries
(AAA x 2)



registration card
(1EMN24699)



Phillips pan screw for
attaching the stand x 4
(FPH34200)



- If you need to replace these accessories, please refer to the part No. with the illustrations and call our toll free customer support line found on the cover of this manual.

✓ Attaching the Stand

You must attach the stand to the unit to display upright. Be sure the front and rear of the stand match the proper direction.

- 1** Spread a thick and soft cloth over a table. Place the main unit face down onto it. Make sure not to damage the screen. At least two people are required at this step.
- 2** Hang the hook under the bottom of the main unit to the stand's hole (shown arrow ①), then slide down the stand in the direction of the screen (shown arrow ②). Make sure not to put the AC power cord between the stand and the unit.
- 3** Drive Phillips pan screws in the 4 threaded holes at the bottom of the stand with a screwdriver tightly.

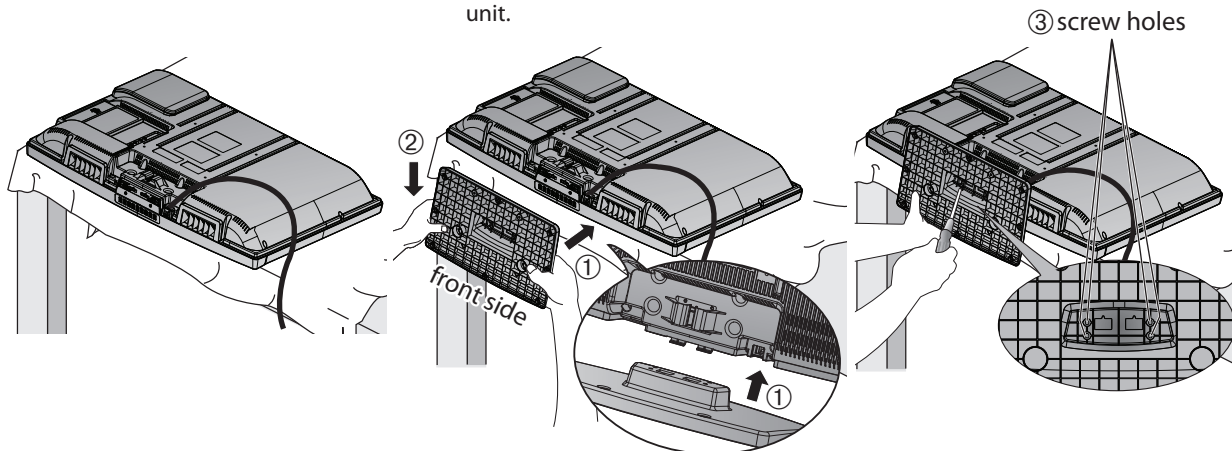

To remove the stand from this unit

Unscrew the Phillips pan screws indicated by "③". Pull up the stand in the direction of the rear of the unit. Be careful not to drop the stand when you remove it.

Note:

- When attaching the stand, ensure that all screws are tightly fastened. If the stand is not properly attached, it could cause the unit to fall, resulting in injuries as well as damage to the unit.
- Make sure to use a table which can support the weight of this unit and is larger than this unit.
- Make sure the table is in a stable location.

✓ Features

TV

- **DTV/TV/CATV**
 - You can use your remote control to select channels which are broadcast in digital format and conventional analog format. Also, cable subscribers can access their cable TV channels.
- **Information Display (DTV only)**
 - You can display the title, contents and other information of the current DTV program on the TV screen.
- **Autoprogram**
 - This unit automatically scans and memorizes channels available in your area, eliminating difficult setup procedures.
- **Child Lock**
 - This feature allows you to block children's access to inappropriate programs.
- **Closed Caption Decoder**
 - Built-in closed caption decoder displays text for closed caption supported programs.
- **MTS/SAP Tuner**
 - Audio can be selected from the remote control.
- **Auto Shut Off Function**
 - If there is no signal input from the antenna terminal and no operation for 15 minutes, the unit will turn off automatically.
- **Sleep Timer**
 - This feature will automatically turn off the power of the unit at a specific time.
- **Choices for On-screen Language**
 - Select your on-screen language: English, Spanish or French.
- **Stereo Sound Function**
- **PLL Frequency Synthesized Tuning**
 - Provides free and easy channel selection and lets you tune directly to any channel using the number buttons on the remote control.
- **Various Adjustment for Picture and Sound**
 - Customizes image quality to suitable for your room, and set the sound as your preference.
- **HDMI Input**
 - When using HDMI1 input, you can enjoy this unit as a PC monitor if your PC has DVI output terminal.
- **Component Video Input**
- **S-video Input**
- **AV Input**
- **Digital Audio Output**
- **Analog Audio Output**

DVD

- **Dolby Digital Sound**
 - Enjoy Dolby Digital multi-channel surround sound when you connect the unit to your Dolby Digital decoder.
- **Still / Fast / Slow / Step Playback**
 - Various playback modes are available including still pictures, fast forward/reverse, slow motion and step frames.
- **DVD Menus in a Desired Language**
 - You can display DVD menus in a desired language, if available on a DVD-video.
- **Auto Power Off**
 - If there is no operation for 20 minutes, the unit will turn itself off automatically.
- **Parental Lock**
 - Block the viewing of DVD-video unsuitable for children.
- **Resume Playback**
 - Lets you resume playback from the point at which playback was stopped.
- **Bit Rate Indication**
- **DRC (dynamic range control)**
 - You can control the range of sound volume.

Accessing from [MODE] button

During playback

- **Subtitles in a Desired Language**
 - You can select a desired language for displaying subtitle, if that language is available on a DVD-video.
- **Selecting a Camera Angle**
 - You can select the desired camera angle, if a DVD contains sequences recorded from different angles.
- **Zoom**
 - Allows you to enlarge the size of picture image.
- **Black Level Adjustment**
- **Virtual Surround**
- **Search**
 - chapter search / title search / track search / time search
- **Marker**
 - The part on the disc designated by user can be called back.
- **Repeat**
 - chapter / title / track / all / A-B

Accessing from [MODE] button

In Stop mode

- **Program Playback for audio CD**
 - You can program the order of tracks to play them back in designated order.
- **Random Playback for audio CD**
 - This unit can shuffle the order of tracks to play them back in randomly.

Accessing from [SAP/AUDIO] button

During playback

- **Choices for Audio Language and Stereo Sound Function**
 - Select your desired languages or stereo sound function when different options are available on your disc.

☑ Contents

Important Safety Instructions	3
-------------------------------------	---

INTRODUCTION

Precaution	4
Trademark Information	5
Symbols Used in this Manual	5
Supplied Accessories	6
Attaching the Stand	6
Features	7
Control Panel	9
Rear Panel	9
Remote Control Function	10
Installing the Batteries	11

PREPARATION

Antenna Connection	12
Connection to Cable Receiver or Satellite Box	12
External Device Connection	13
Cable Management	16
Plug In the AC Power Cord	16

TV Functions

Initial Setup	17
---------------------	----

WATCHING TV

Channel Selection	18
Volume Adjustment	18
Sleep Timer	18
Still Mode	19
Switching Each Input Mode	19
Switching Audio Mode	19
TV Screen Information	20
TV Screen Display Mode	21

OPTIONAL SETTING

Main Menu	22
Autoprogram	22
Channel List	23
Add Channels	23
Antenna Confirmation	24
Language Selection	24
Picture Adjustment	25
Sound Adjustment	26
Closed Caption	27
Child Lock	30
PC Settings	34
Energy Saving Mode	35
Location	35
Current Software Info	36

DVD Functions

OPERATING DVD

Playable Media	37
Unplayable Media	37
Playback	38
Disc Menu	38
Resume Playback	38
Paused and Step-by-step Playback	38
Fast Forward / Fast Reverse	39
Slow Forward / Slow Reverse	39
Zoom	39
Search Functions	40
Repeat Playback	41
Repeat A-B Playback	42
Random Playback	42
Programmed Playback	42
On-screen Display	43
Special Settings	43

DVD SETTING

DVD Language Setting	46
DVD Audio Setting	47
Parental Setting	48
Others	49
Reset to the Default Setting	50
Language Code List	50

TROUBLESHOOTING

FAQ	51
Troubleshooting Guide	52

INFORMATION

Glossary	54
Maintenance	54
Cable Channel Designations	55
General Specifications	55
Electrical Specification	55
Other Specifications	55

Limited Warranty	56
------------------------	----

© 2009 Funai Electric Co., Ltd.

All rights reserved. No part of this manual may be reproduced, copied, transmitted, disseminated, transcribed, downloaded or stored in any storage medium, in any form or for any purpose without the express prior written consent of Funai. Furthermore, any unauthorized commercial distribution of this manual or any revision hereto is strictly prohibited.

Information in this document is subject to change without notice. Funai reserves the right to change the content herein without the obligation to notify any person or organization of such changes.

FUNAI with the  design is a registered trademark of Funai Electric Co., Ltd and may not be used in any way without the express written consent of Funai. All other trademarks used herein remain the exclusive property of their respective owners. Nothing contained in this manual should be construed as granting, by implication or otherwise, any license or right to use any of the trademarks displayed herein. Misuse of any trademarks or any other content in this manual is strictly prohibited. Funai shall aggressively enforce its intellectual property rights to the fullest extent of the law.

✓ Control Panel

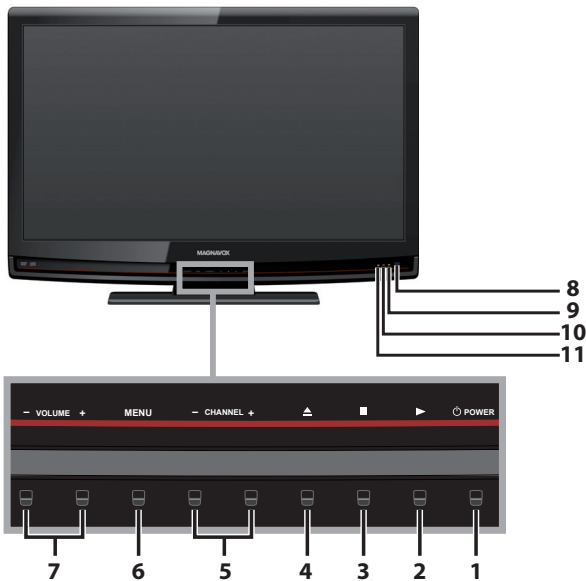

1. **⏻ POWER** (p. 17)
Press to turn the unit on and off.
2. **▶ (play)** (p. 38)
Press to begin the disc playback.
3. **■ (stop)** (p. 38)
Press to stop the disc playback.
4. **▲ (eject)** (p. 38)
Press to eject the disc.
5. **CHANNEL + / -** (p. 18 / p. 19)
Press to select channels or move up (+) / down (-) through the main menu items.
6. **MENU** (p. 17 / p. 46)
Press to display the main menu.
7. **VOLUME + / -** (p. 18)
Press to adjust the volume or move right (+) / left (-) through the main menu items.
8. **infrared sensor window**
Receives infrared rays transmitted from the remote control.
9. **POWER ON indicator**
Lights up green when power is on.
10. **STAND BY indicator**
Lights up red when power is off.
11. **DVD indicator**
Lights up orange when the disc is inserted.

✓ Rear Panel

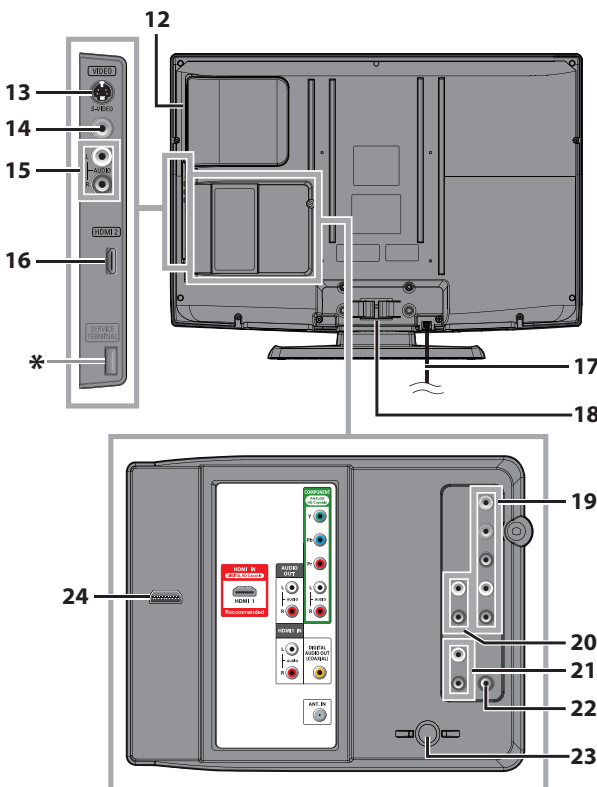

12. **disc loading slot** (p. 38)
Insert the disc with the label side facing forward.
13. **S-video input jack** (p. 14)
S-video cable connection for an external device.
14. **video input jack** (p. 15)
RCA video cable connection for an external device.
15. **audio input jack** (p. 14 / p. 15)
RCA audio cable connection for an external device.
16. **HDMI 2 input jack** (p. 12 / p. 13)
HDMI connection for HDMI device.
17. **AC power cord** (p. 16)
Connect to a standard AC outlet to supply power to this unit.
18. **cable management** (p. 16)
Use this holder to bundle the cables.
19. **component video and audio input jack** (p. 12 / p. 14)
RCA component video cable and RCA audio cable connection for an external device.
20. **audio output jack** (p. 15)
RCA audio cable connection for an external device.
21. **audio input jack for HDMI 1** (p. 13 / p. 16)
RCA audio cable connection for a DVI device.
When you connect your PC that has a DVI terminal, use a stereo mini plug-RCA conversion cable as well. (For HDMI 1 input jack only)
22. **digital audio output jack** (p. 15)
Coaxial digital cable connection for a decoder or an audio receiver.
23. **antenna input jack** (p. 12)
RF coaxial cable connection for your antenna or cable TV signal.
24. **HDMI 1 input jack** (p. 12 / p. 13 / p. 16)
HDMI connection for HDMI or DVI device.
When you connect your PC that has a DVI terminal, you can enjoy this unit as a PC monitor.

Note:

* service terminal (service use only)

Use this terminal only when a software update is necessary. Do not connect any device to this terminal such as; digital camera, keyboard, mouse, etc. For more information, please visit at www.magnavox.com/support

Remote Control Function

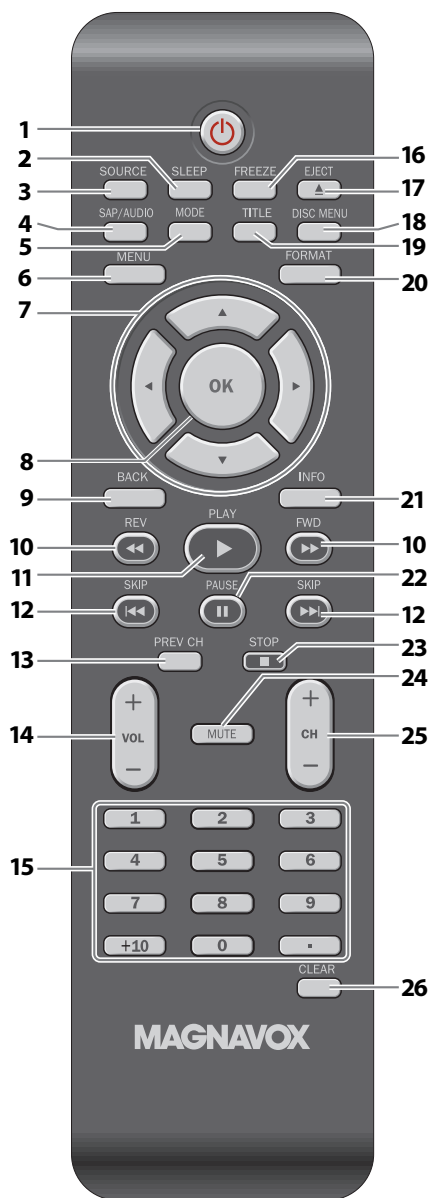

1. **Power** (p. 17)
Press to turn the unit on and off.
2. **SLEEP** (p. 18)
Press to activate the sleep timer.
3. **SOURCE** (p. 19)
Press to access connected external devices like a BD/DVD recorder.
4. **SAP/AUDIO** (p. 19)
Digital mode (DTV)
• Press to select the audio language.
Analog mode (TV)
• Press to select the audio mode.
DVD mode
• Press to select the audio language (DVD), or sound mode (CD).
5. **MODE** (p. 7)
• Press to arrange the playing order or playback randomly (CD).
• Press to set the black level (DVD) and the virtual surround on or off.
• Press to change the camera angle to see the sequence being played back from different angle (DVD).
• Press to search chapter, title (DVD), track (CD) or time.
• Press to set the marker.
• Press to repeat playback chapter, title (DVD), track, disc (CD) repeatedly or between designated point A and B.
• Press to magnify the part of picture (2x and 4x : DVD).
• Press to select the subtitles on a disc (DVD).
6. **MENU** (p. 17)
Press to display the main menu.
7. **Left/Right/Up/Down** (p. 17)
Press to move left / right / up / down through the items.
8. **OK** (p. 17)
Press to decide the command of setting when the main menu is displayed.
9. **BACK** (p. 20)
Press to return to the previous menu operation.

When using a universal remote control to operate this unit.

- Make sure the component code on your universal remote control is set to our brand. Refer to the manual accompanying your remote control for more details.

10. REV ◀◀ / FWD ▶▶ (p. 39)

Press to begin slow forward or slow reverse playback during the pause mode (DVD) and search forward or backward through a disc.

11. PLAY ▶ (p. 38)

Press to begin disc playback.

12. SKIP |◀◀ / ▶▶| (p. 40)

Press to skip forward or backward chapters, titles (DVD) or tracks (CD).

13. PREV CH (p. 18)

Press to return to the previous channel.

14. VOL + / - (p. 18)

Press to adjust the volume.

15. Number buttons (p. 18)

- Press to select channels.
- Press to select chapter, title (DVD), or track (CD) directly.
- **(dot)**
- Press to shift the subchannel from the main channel.
- +10 button**
- Press to select 10 or higher number of chapters.

16. FREEZE (p. 19)**TV mode**

- Press to pause screen image.

17. EJECT ▲ (p. 38)

Press to eject the disc.

18. DISC MENU (p. 38)

Press to display the menu on a disc.

19. TITLE (p. 38)

Press to display the title menu (DVD).

20. FORMAT (p. 21)

Press to select aspect ratio available for the TV screen.

21. INFO (p. 20 / p. 43)**Digital mode (DTV)**

- Press to display the channel information, signal type and TV setting.

Analog mode (TV)

- Press to display the channel number, signal type and TV setting.

External input mode

- Press to display the external input modes, signal type and TV setting.

DVD mode

- Press to display the current status.

22. PAUSE II (p. 38)**DVD mode**

- Press to pause disc playback.

23. STOP ■ (p. 38)

Press to stop disc playback.

24. MUTE (p. 18)

Press to turn the sound on and off.

25. CH + / - (p. 18 / p. 19)

Press to select channels and the external input modes.

26. CLEAR (p. 41)

- Press to clear the numbers entered incorrectly.
- Press to cancel the point A for A-B repeat.
- Press to remove the track number in program input (CD).

✓ Installing the Batteries

Install the batteries (AAA x 2) matching the polarity indicated inside battery compartment of the remote control.

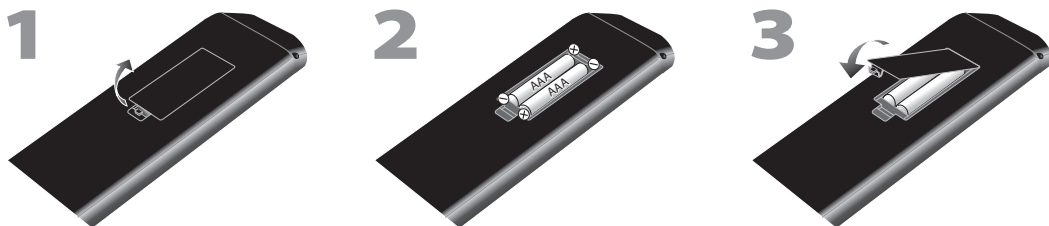
**Battery Precautions:**

- Be sure to follow the correct polarity as indicated in the battery compartment. Reversed batteries may cause damage to the device.
- Do not mix different types of batteries together (e.g., Alkaline and Carbon-Zinc, or rechargeable batteries like ni-cad, ni-mh, etc) or old batteries with fresh ones.
- If the device is not to be used for a long period of time, remove the batteries to prevent damage or injury from possible battery leakage.
- Do not try to recharge batteries; they can overheat and rupture.

No supplied cables are used in this connection:

Please purchase the necessary cables at your local store.
High Speed HDMI cable (also known as HDMI category 2 cable) is recommended for the better compatibility.

Before you connect...

Be sure your antenna or other device is connected properly before plugging in the AC power cord.

✓ Antenna Connection

Connect the RF coaxial cable on your home outlet to the antenna input jack of this unit.

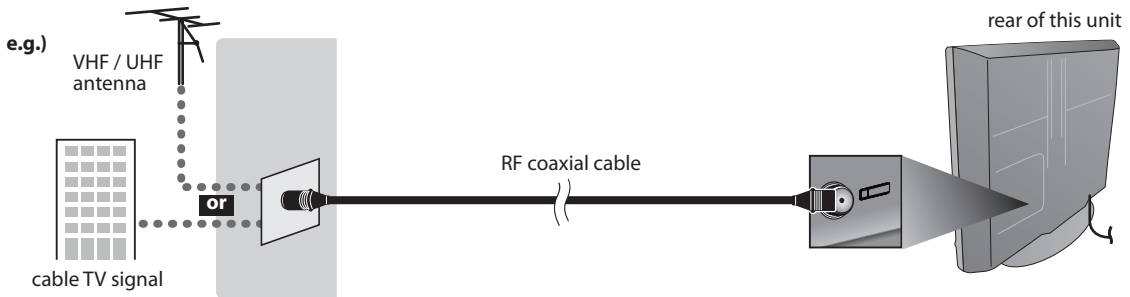

* Once connections are completed, turn on the unit and begin initial setup. Channel scanning is necessary for the unit to memorize all available channels in your area. (Refer to "Initial Setup" on page 17.)

Note:

- If you have any question about the DTV's antenna, visit www.antennaweb.org for further information.
- Depending on your antenna system, you may need different types of combiners (mixers) or separators (splitters). Contact your local electronics store for these items.
- For your safety and to avoid damage to this unit, please unplug the RF coaxial cable from the antenna input jack before moving the unit.
- If you use an antenna to receive analog TV, it should also work for DTV reception. Outdoor or attic antennas will be more effective than settop versions.
- To switch your reception source easily between antenna and cable, install an antenna selector.
- If you connect to the cable system directly, contact the CATV installer.

✓ Connection to Cable Receiver or Satellite Box

Use an HDMI or an RCA component video cable to connect the HDMI or the component video input jack of the unit to the HDMI or the component video output jack of the cable receiver / satellite box.

If you connect to the unit's COMPONENT video input jack, connect an RCA audio cable to the audio L/R jack of COMPONENT accordingly.

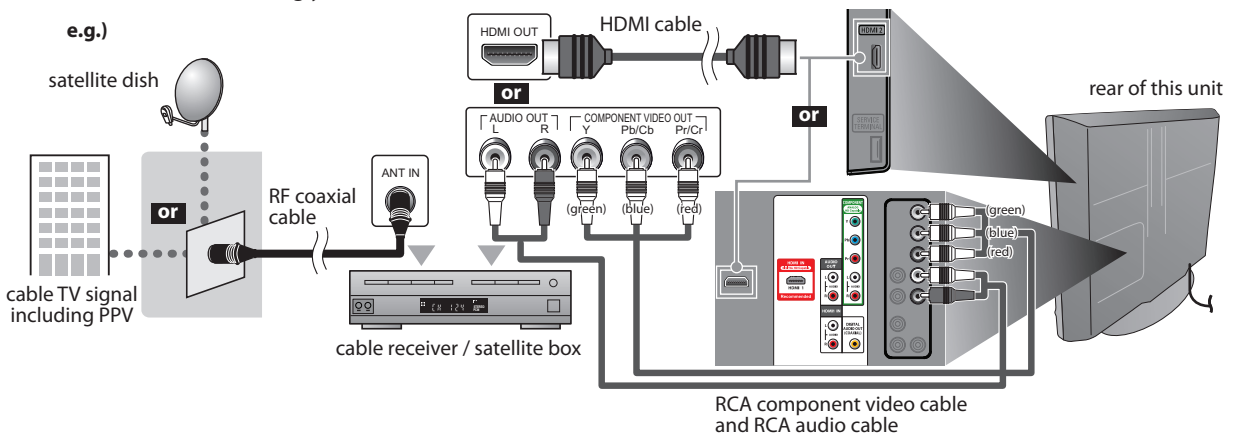

- * You can also connect this unit to the cable receiver or satellite box other than the HDMI or the component video output jack because they might have different output jacks.
- * Required cables and connecting methods of the cable receiver / satellite box, or the availability channel for the clear QAM may differ depending on the cable / satellite provider. For more information, please contact your cable / satellite provider.

No supplied cables are used in this connection:

Please purchase the necessary cables at your local store.
High Speed HDMI cable (also known as HDMI category 2 cable) is recommended for the better compatibility.

External Device Connection

[HDMI Connection]

HDMI connection offers the highest picture quality.
HDMI (High-Definition Multimedia Interface) transports high definition video and multi-channel digital audio through a single cable.

e.g.)

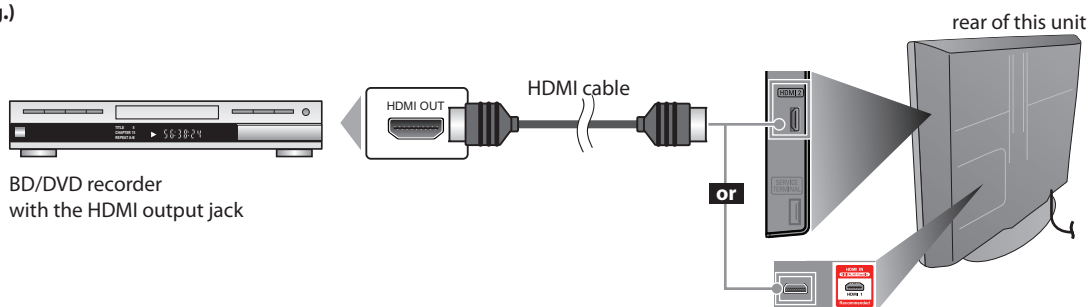

Note:

- This unit accepts 480i / 480p / 720p / 1080i video signals, and 32kHz / 44.1kHz / 48kHz audio signals.
- This unit accepts only 2 channel audio signal (LPCM).
- You need to select "PCM" for the digital audio output of the device you connected or check the HDMI audio setting. There may be no audio output if you select "Bitstream", etc.
- This unit only accepts signals in compliance with EIA861.

[HDMI-DVI Connection]

Use an HDMI-DVI conversion cable to connect the unit to external video devices equipped with DVI output jack.

e.g.)

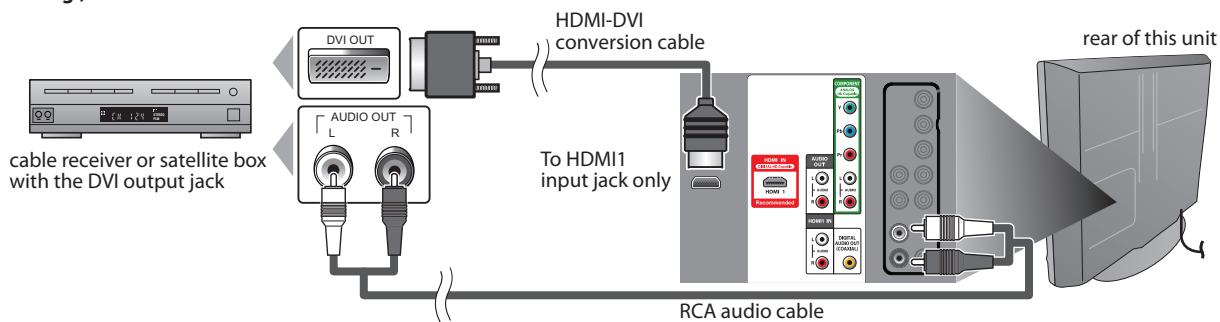

Note:

- This unit accepts 480i / 480p / 720p / 1080i video signals.
- HDMI-DVI connection requires separate RCA audio connection as well.
- Audio signals are converted from digital to analog for this connection.
- DVI does not display 480i image that is not in compliance with EIA/CEA-861/861B.

No supplied cables are used in this connection:

Please purchase the necessary cables at your local store.

[Component Video Connection]

RCA component video connection offers better picture quality for video devices connected to the unit. If you connect to the unit's COMPONENT video input jack, connect an RCA audio cable to the audio L/R jack of COMPONENT accordingly.

e.g.)

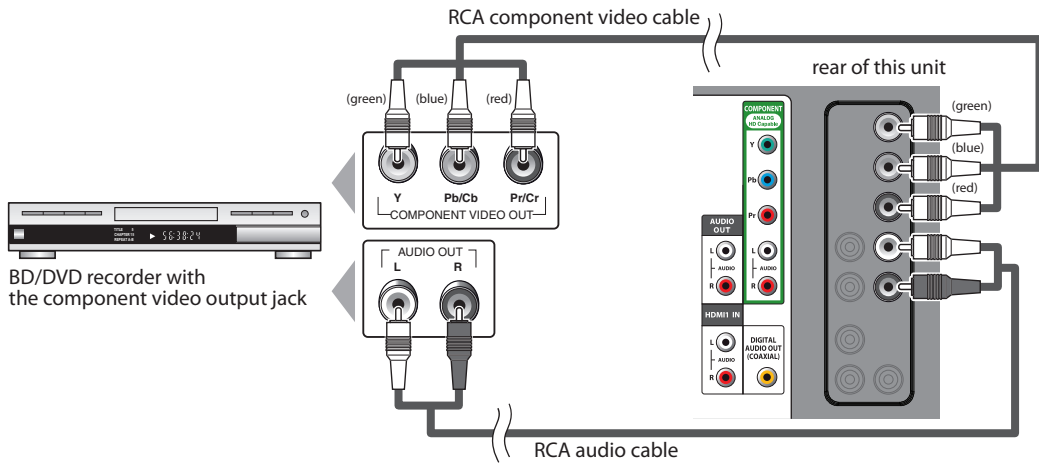

Note:

- This unit accepts 480i / 480p / 720p / 1080i video signals.

[S-video Connection]

S-video connection offers good picture quality for video devices connected to the unit. If you connect to the unit's S-video input jack, connect an RCA audio cable to the audio L/R jack of VIDEO accordingly.

e.g.)

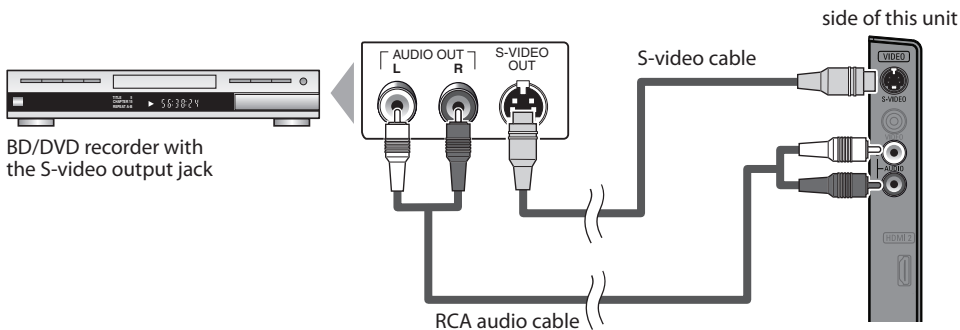

Note:

- If you connect to the S-video input jack and the video input jack at the same time, the S-video connection will have priority.

No supplied cables are used in this connection:

Please purchase the necessary cables at your local store.

[Video Connection]

RCA video connection offers standard picture quality for video devices connected to the unit.

If you connect to the unit's video input jack, connect an RCA audio cable to the audio L/R jack of VIDEO accordingly. When the audio jack of the video device is monaural, connect an RCA audio cable to the audio L input jack.

e.g.)

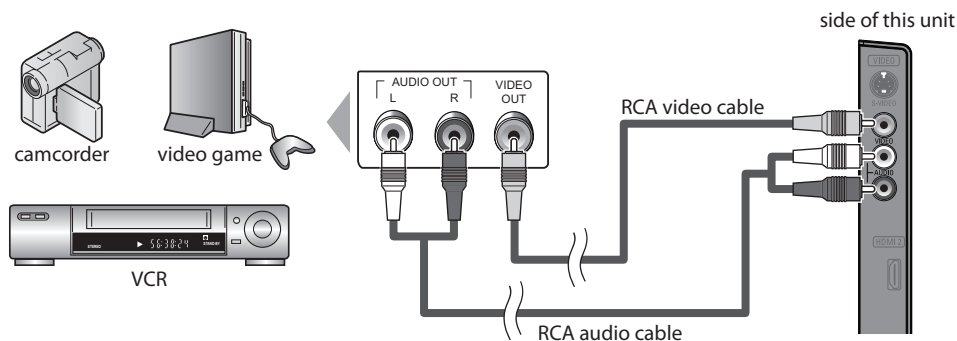
**Note:**

- If you connect to the S-video input jack and the video input jack at the same time, the S-video connection will have priority.

[Audio Output Connection]*** Digital** (for digital broadcasting only)

If you connect this unit to an external digital audio device, you can enjoy multi-channel audio like 5.1ch digital broadcasting sound.

Use a digital audio coaxial cable to connect the unit to external digital audio devices.

*** Analog** (for both analog and digital broadcasting)

If you connect this unit to an external analog audio device, you can enjoy stereo (2-channel) audio.

Use an RCA audio cable to connect the unit to external analog audio devices.

e.g.)

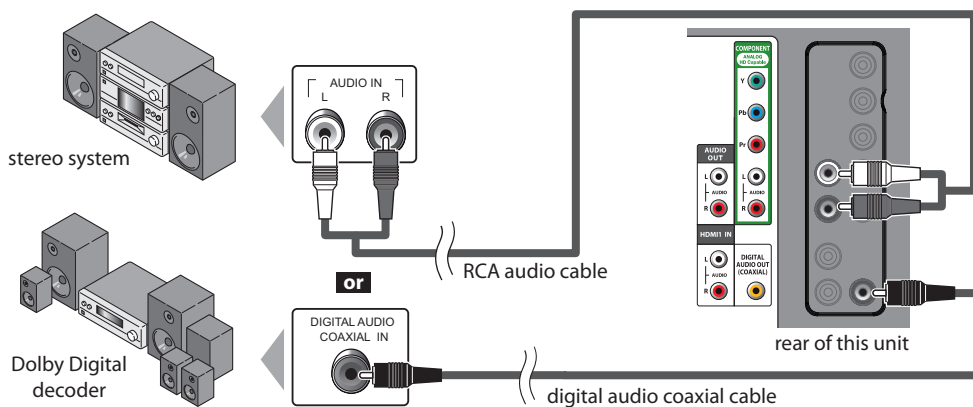

No supplied cables are used in this connection:

Please purchase the necessary cables at your local store.

[PC Connection]

This unit can be connected to your PC that has a DVI terminal. Use an HDMI-DVI conversion cable for this connection and it requires stereo mini plug-RCA conversion cable as well.

If you connect this unit to your PC, you can use this unit as a PC monitor.

e.g.)

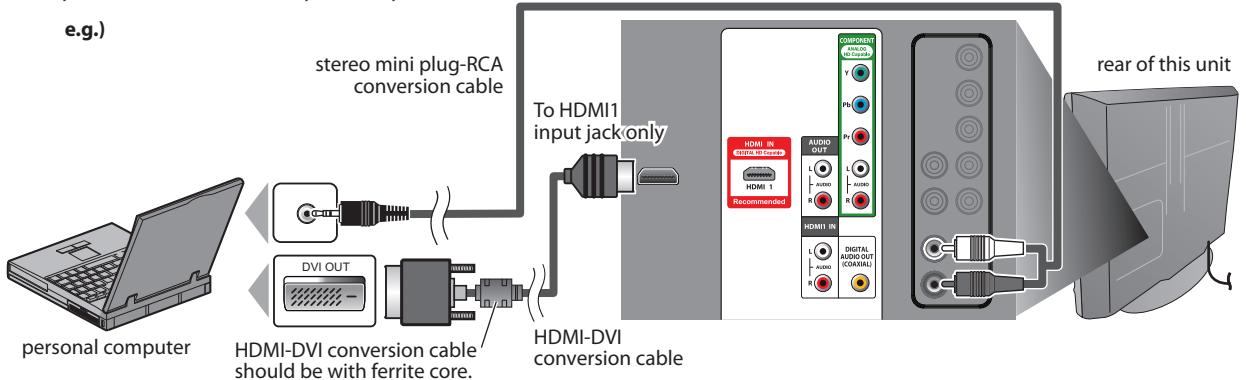

The following signals can be displayed:

Format	Resolution	Refresh rate
VGA	640 x 480	60Hz
SVGA	800 x 600	60Hz
XGA	1,024 x 768	60Hz

Format	Resolution	Refresh rate
WXGA	1,280 x 768	60Hz
	1,360 x 768	60Hz

Other formats or non-standard signals will not be displayed correctly.

Note:

- Please purchase the HDMI-DVI conversion cable that has a ferrite core.
- The following operations may reduce noise.
 - Attach a ferrite core to the AC power cord of your PC.
 - Unplug the AC power cord and use the built-in battery of your PC.

✓ Cable Management

Keep the cables through this holder to avoid tangle them.

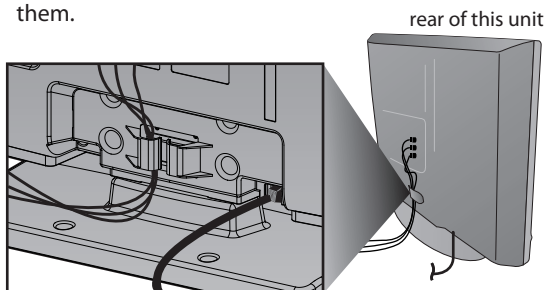

✓ Plug In the AC Power Cord

Make sure that the AC power cord must be plugged to an AC outlet after all the necessary connection is completed.

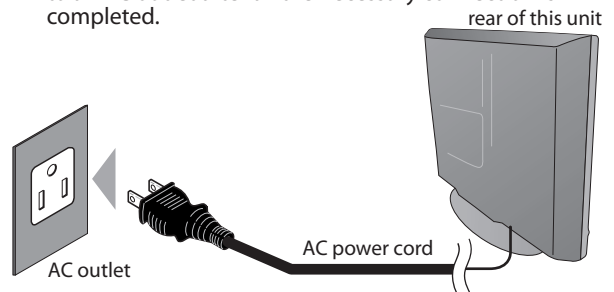

Caution:

- Do not connect the AC power cord to a power supply outside the indicated voltage of this unit (AC 120V). Connecting the AC power cord to a power supply outside of this range may result in fire or electrical shocks.

Note:

- Each time you plugged in the AC power cord, any operations will not be performed for a few seconds. This is not a malfunction.

These operations are accessible by remote control. Some may also be accessible by controls on the main unit.

TV Functions

✓ Initial Setup

This section will guide you through the unit's initial setting which includes selecting a language for your on-screen menu and autoprogram, which automatically scans and memorizes viewable channels.

Before you begin:

Make sure if the unit is connected to antenna or cables.

- After making all the necessary connections, press [Power] to turn on the unit.



- This operation may take a few moments.

- Use [Cursor ▲/▼] to select the on-screen language from the choices on the right side of the TV screen. (English / Español / Français)

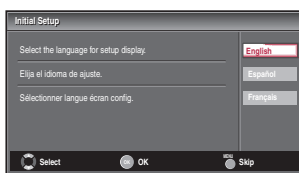

- "Initial Setup" menu on step 3 will be displayed in the selected language after you press [OK].

- Use [Cursor ▲/▼] to select "Antenna" for TV channels or "Cable" for CATV channels, then press [OK].

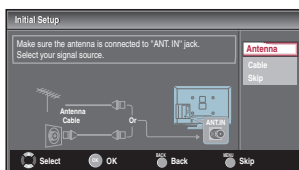

- "Autoprogram" will begin.

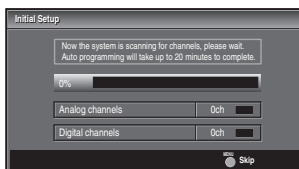

- Use [Cursor ◀/▶] to select the desired location setting, then press [OK].

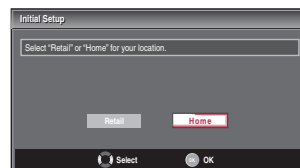
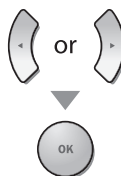

- Select "Retail", the unit will be set up with predefined setting for retail displays. In this setting, the power consumption may possibly exceed the limited requirement of the ENERGY STAR® qualification.
- Select "Home", the unit is set to maximize the energy efficiency for home setting and it can be adjusted through a choice of picture and sound quality according to your preference.
- When the initial setup is completed, the lowest memorized channel with the confirmation message of the location setting will be displayed on the TV screen.

Note:

- If you connect the cable system directly, contact the CATV installer.
- If you press [Power] or [MENU] during autoprogram, this setting will be canceled.
- The initial autoprogram function can be executed for either "Antenna" or "Cable" only once. When you change the connection (Antenna / Cable), set autoprogram again. (Refer to page 22.)
- If there is no signal input from the antenna terminal and no operation for several seconds after you turn on the unit, "Helpful Hints" appears. Follow the instructions listed on the TV screen.

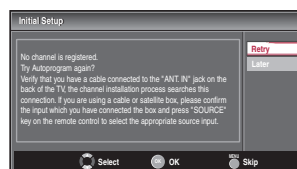

- You must set "Home" in step 4. Otherwise, the settings of picture and sound quality you adjusted will not be memorized after you turn off the unit.

After an initial setup is completed...

- If you want to scan the channels automatically again, refer to "Autoprogram" on page 22.
- You can add the desired channels unmemorized by "Autoprogram". Refer to "Add Channels" on page 23.
- If you want to change the other language from the one you chose, refer to "Language Selection" on page 24.
- If you want to change the mode for location setting, refer to "Location" on page 35.

✓ Channel Selection

Select channels by using [CH + / -] or [the Number buttons].

- To select the memorized channels, use [CH + / -] or [the Number buttons].
- To select the non-memorized channels, use [the Number buttons].

To Use [the Number buttons]

TV

- When selecting analog channel 11



DTV

- When selecting digital channel 11.1
Be sure to press [•] before entering the subchannel number.



- Press [PREV CH] to return to the previously viewed channel.

About digital TV broadcasting:

With its high definition broadcast, digital broadcasting far surpasses analog broadcasting in both its picture and sound quality. Not all digital TV broadcasts are high definition (HD). To confirm whether your watching TV program is in HD, refer to the program guide, contact your cable/satellite provider or local TV stations.

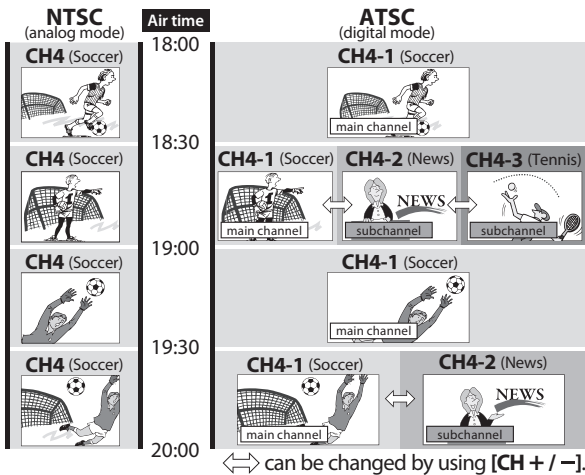

What is the subchannel?

By using high compression technology, digital broadcasting offers a service that enables multiple signals to send simultaneously. Therefore, you can select more than one program per main channel since digital broadcasting technology distinguishes between multiple channels broadcast by a single network.

Note:

- "No Signal" will appear on the TV screen after the subchannel broadcast is over.
- "Audio only program" message will appear on the TV screen, when you receive only sound signal.

✓ Volume Adjustment

This section describes how to adjust the volume. The mute function, which turns the sound off and on, is also described.

Use [VOL + / -] to adjust the audio volume.



The volume bar will be displayed at the bottom of the TV screen when adjusting the volume.

- The volume bar will automatically disappear in a few seconds.

Press [MUTE] to turn off and on the sound.



"Mute" is displayed on the TV screen for a few seconds.

Press [MUTE] again or [VOL + / -] to recover the original volume.

✓ Sleep Timer

The sleep timer can be set to automatically turn off the unit after an incremental period of time.

- Press [SLEEP] to set the sleep timer.



Sleep timer display appears on the TV screen.

- Press [SLEEP] repeatedly to change the amount of time until shut off.



You can set your unit to turn off after a set period of time (from 30 to 120 minutes).

- Each press of [SLEEP] will increase the time by 30 minutes.
- After setup, the sleep timer display can be called up for checking by pressing [SLEEP].

To cancel the sleep timer

Press [SLEEP] repeatedly until "Sleep Off" is displayed on the TV screen.

Note:

- The sleep timer display will automatically disappear in a few seconds.
- When you disconnect the unit from the AC outlet or when a power failure occurs, the sleep timer setting will be canceled.

Still Mode

You can pause the image shown on the TV screen.

Press [FREEZE] to pause the image shown on the TV screen.



- The sound output will not be paused.
 - If no signal is detected or protected signal is received during still mode, the image remains paused and the sound output will be muted.
 - The still function will be released after 5 minutes.
- To cancel still mode, press any button except [power].

Switching Each Input Mode

You can easily switch with the remote control to the DTV (ATSC) and TV (NTSC) or to access external devices when they are connected to the unit.

Press [SOURCE] or [CH +] repeatedly to cycle through the input modes.

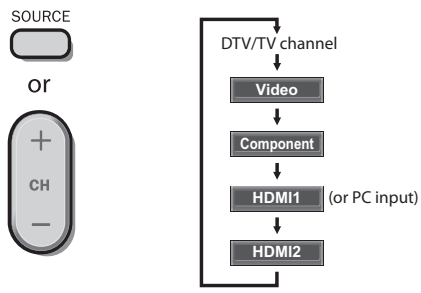

- Pressing [CH -] reverses the direction of the input modes.

Switching Audio Mode

This section describes how to switch the audio in the analog mode and how to switch the audio language in the digital mode.

TV

Press [SAP/AUDIO] to display the currently selected audio mode. While receiving an MTS broadcast, press repeatedly to cycle through the available audio channel.



When all audio are available



When stereo and monaural audio are available



When SAP and monaural audio are available



When only monaural audio is available



- STEREO** : Outputs stereo-audio
- SAP** : Outputs second audio program
- MONO** : Outputs mono-audio

DTV

1 Press [SAP/AUDIO] to display the currently selected language and the number of available languages.



2 Press [SAP/AUDIO] repeatedly to cycle through the available audio languages.



- Available languages differ depending on the broadcast. "Other" is displayed when the audio language cannot be acquired, or the acquired languages are other than English, Spanish or French.

Note:

- [SAP/AUDIO] does not control external audio devices.
- The information display will automatically disappear in a few seconds.

✓ TV Screen Information

You can display the currently selected channel or other information such as the audio mode on the TV screen.

TV

In the analog mode, the current channel number and the audio mode are displayed.

Press **[INFO]**.

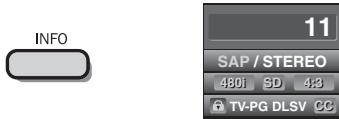

- The current channel number, audio mode, type of resolutions for video signal, TV aspect ratio, CC and TV program rating are displayed on the top-right corner of the TV screen.
- To clear the display, press **[INFO]** again. You can also press **[BACK]**.

DTV

In the digital mode, the detailed broadcasting information for the current channel such as program title, program guides are displayed.

Press **[INFO]** to display the details of the currently selected program.



Broadcasting information

The following information is displayed.

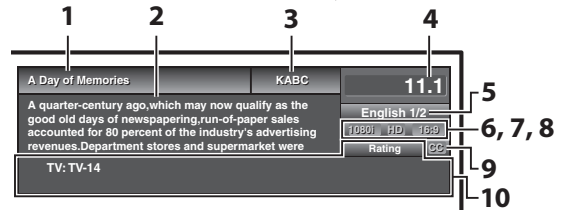

- 1 program title
- 2 program guide
(The program guide added to broadcasting information is displayed to a maximum of 4 lines.)
- 3 broadcast station
- 4 channel number
- 5 audio language
(Refer to "Switching Audio Mode" on page 19.)
- 6 effective scanning lines and scan mode
- 7 digital TV format
- 8 program aspect ratio
- 9 CC (not available if closed caption is set to "Off")
- 10 Child Lock rating

Note:

- When the program guide consists of more than 4 lines, use **[Cursor ▲/▼]** to scroll.
- "No description provided." is displayed when the program guide is not provided.
- While the program guide is displayed, the closed caption function is interrupted.
- In external input mode, the following screen is displayed; e.g.) When an external device is connected to VIDEO input jack.

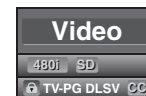

- The information display will automatically disappear in 1 minute.

✓ TV Screen Display Mode

4 types of display modes can be selected when the broadcasting station is sending 4:3 or 16:9 video signal. And 3 types of display modes can be selected for PC input signal.

Press [**FORMAT**] repeatedly to switch the TV aspect ratio.

FORMAT



For 4:3 video signal

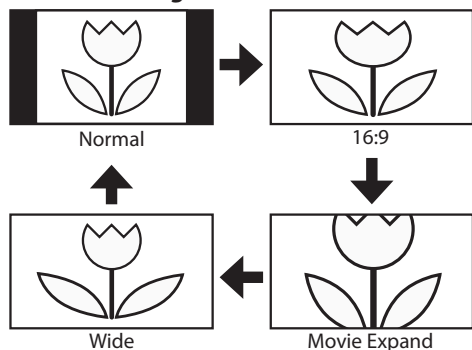

Normal

Display a 4:3 picture at its original size. Sidebars appear on both edges of the screen.

16:9

Display a 4:3 picture at a 16:9 size; the picture is stretched horizontally to fill the screen.

Movie Expand

Display a 4:3 picture at a 16:9 size; the picture is stretched horizontally and vertically to fill the screen. This crops out the top and bottom of the picture.

Wide

Display the picture with its center at the original size and the edges stretched horizontally.

For 16:9 video signal

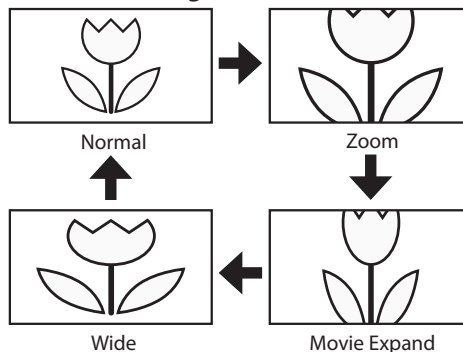

Normal

Display a 16:9 picture at its original size.

Zoom

Display a 16:9 picture at its maximum size without changing its horizontal and vertical ratio.

Movie Expand

Display a vertically stretched picture.

Wide

Display a horizontally stretched picture.

For PC input signal through **HDMI1** input mode

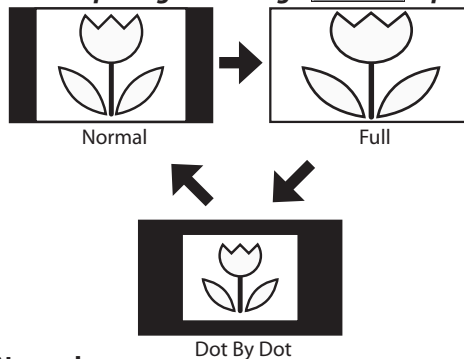

Normal

Display a proportionately stretched picture. Sidebars appear on both edges of the screen.

Full

Display a picture that is stretched out of proportion to fill the screen.

Dot By Dot

Display a picture in its original size.

✓ Main Menu

This section describes the overview of the main menu displayed when you press [MENU]. For more details, see the reference page for each item. The main menu consists of the function setting items below.

Press [MENU].

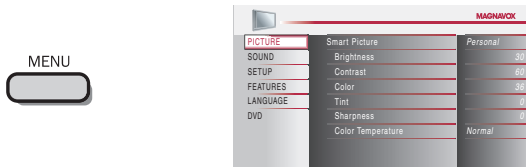

PICTURE

You can adjust the picture quality. (Refer to "Picture Adjustment" on page 25.)

SOUND

You can adjust the sound quality. (Refer to "Sound Adjustment" on page 26.)

SETUP

- You can automatically scan the viewable channels. (Refer to "Autoprogram" on page 22.)
- You can skip the undesired channels when selecting the channels using [CH + / -]. (Refer to "Channel List" on page 23.)
- You can add the channels that were not scanned by the autoprogram. (Refer to "Add Channels" on page 23.)

FEATURES

- You can change the display format for closed caption, which displays the dialogue of a TV program or other information across the TV screen. (Refer to "Closed Caption" on page 27.)
- You can set the viewing limitations. (Refer to "Child Lock" on page 30.)
- You can adjust the position, stability and clarity of the PC screen. (Refer to "PC Settings" on page 34.)
- You can select the energy saving mode. (Refer to "Energy Saving Mode" on page 35.)
- When you adjust the desired "PICTURE" and "SOUND" mode, you must switch the setting from "Retail" to "Home". (Refer to "Location" on page 35.)
- You can confirm the version of the software currently used in this unit. (Refer to "Current Software Info" on page 36.)

LANGUAGE

You can change the language (English, Spanish, French) displayed on the main menu. (Refer to "Language Selection" on page 24.)

DVD

You can customize some functions for the disc playback. Make sure the player is in stop mode. (Refer to "DVD SETTING" section on page 46.)

✓ Autoprogram

If you switch wires (e.g., between antenna and CATV) or if you move the unit to a different area after the initial setting, or if you restore the DTV channel you deleted, you will need to perform autoprogram.

Before you begin: Make sure if the unit is connected to antenna or cables.

- Press [MENU] to display the main menu.



- Use [Cursor ▲/▼] to select "SETUP", then press [OK].

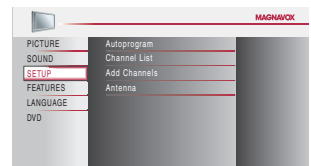

- Use [Cursor ▲/▼] to select "Autoprogram", then press [OK].

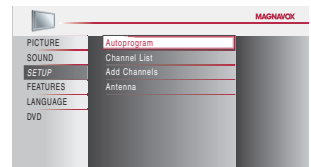

Use [Cursor ▲/▼] to select an appropriate option, then press [OK].

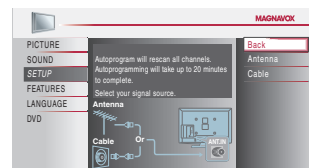

- When aerial antenna is connected, select "Antenna".
- When connected to CATV, select "Cable".
- "Autoprogram" will begin.

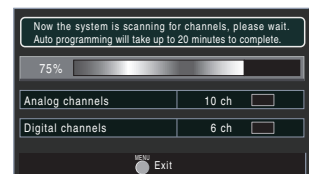

- When the scanning and memorizing are completed, the lowest memorized channel will be displayed.

Note:

- After setting "Autoprogram", using [CH + / -] on the remote control skips unavailable programs automatically.
- If you connect the cable system directly, contact the CATV installer.
- If you press [⏻ (power)] or [MENU] during autoprogram, the setting will be canceled.
- Even if "Autoprogram" is completed, the channel setting will be lost if the AC power cord is unplugged before turning off the unit by pressing [⏻ (power)].
- The PIN Code will be required once you set a PIN Code in the "Child Lock" (Refer to page 30).
- If you want to change your PIN Code, follow the instruction of "Change PIN" (Refer to page 33.)

✓ Channel List

The channels selected here can be skipped when selecting the channels using [CH + / -]. Those channels can still be selected with [the Number buttons].

- 1 Press [MENU] to display the main menu.



- 2 Use [Cursor ▲/▼] to select "SETUP", then press [OK].

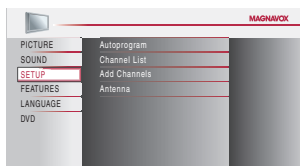

- 3 Use [Cursor ▲/▼] to select "Channel List", then press [OK].

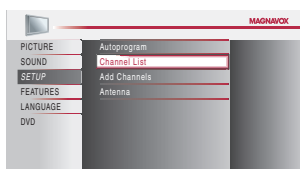

- 4 Use [Cursor ▲/▼] to select the channel you want to remove, then press [OK].

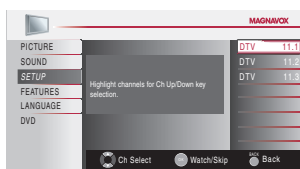

- The channel display for the removed channel darkens. You will not be able to select the channel again using [CH + / -].
- To reactivate a removed channel, use [Cursor ▲/▼] and press [OK]. The registered channels are highlighted.
- When you remove a main channel, its subchannels are removed as well.

Note:

- The channel with the "DTV" indicated on the display is ATSC. Otherwise the channel is NTSC.

- 5 Press [MENU] to exit.



✓ Add Channels

This function lets you add the channels that were not added by the autoprogram due to the receivable condition at the initial setting.

- 1 Press [MENU] to display the main menu.



- 2 Use [Cursor ▲/▼] to select "SETUP", then press [OK].

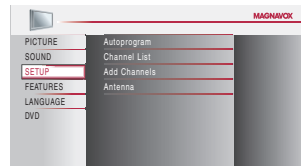

- 3 Use [Cursor ▲/▼] to select "Add Channels", then press [OK].

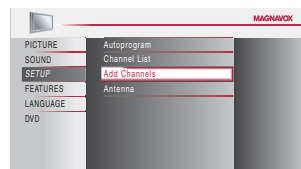

- 4 Use [the Number buttons] to enter the number of the channel you want to add, then press [OK].

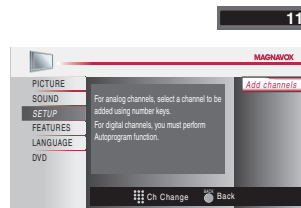
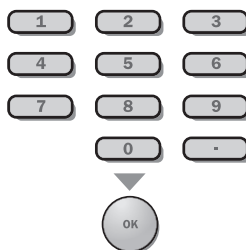

- 5 Press [MENU] to exit.



Note:

- If setup completes successfully, "Added to the channel list" is displayed.
- If external input is used, it is not possible to register the channel and "Unavailable" will be displayed on the TV screen.
- By using [CH + / -], you can select the memorized channels only.

Antenna Confirmation

DTV

This function lets you check the digital signal strength of each channel.

1 Press **[MENU]** to display the main menu.



2 Use **[Cursor ▲/▼]** to select "SETUP", then press **[OK]**.

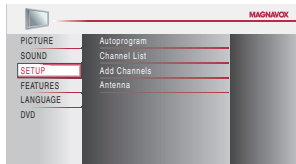

3 Use **[Cursor ▲/▼]** to select "Antenna", then press **[OK]**.

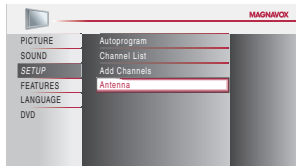

4 Use **[the Number buttons]** or **[CH + / -]** to select the channel for which you want to check the digital signal strength.

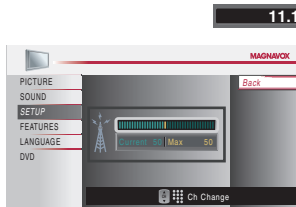
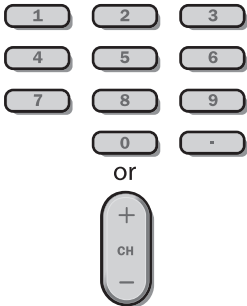

- If the channel is set to analog channel or external input, you cannot confirm the antenna condition.

Video

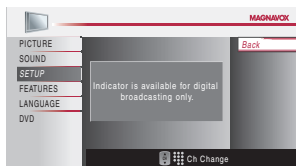

5 Press **[MENU]** to exit.



Language Selection

You can choose English, Spanish, or French as your on-screen language.

1 Press **[MENU]** to display the main menu.



2 Use **[Cursor ▲/▼]** to select "LANGUAGE", then press **[OK]**.



3 Use **[Cursor ▲/▼]** to select "English", "Español" or "Français", then press **[OK]**.

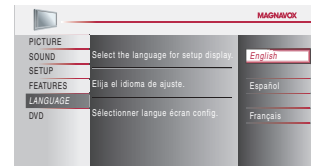

4 Press **[MENU]** to exit.



Note:

- If you need the English menu instead of the Spanish or French menus, press **[MENU]**. Use **[Cursor ▲/▼]** to select "IDIOMA" or "LANGUE", then press **[OK]**. Use **[Cursor ▲/▼]** to select "English", then press **[OK]**. Press **[MENU]** to exit the main menu.

✓ Picture Adjustment

You can adjust brightness, contrast, color, tint, sharpness and color temperature.

Before you begin: You must set "Home" in "Location" (Refer to page 35). Otherwise, the settings you adjusted will not be memorized after you turn off the unit.

- 1 Press [MENU] to display the main menu.



- 2 Use [Cursor ▲/▼] to select "PICTURE", then press [OK].

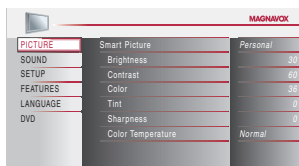

- 3 Use [Cursor ▲/▼] to select the item you want to adjust, then press [OK].

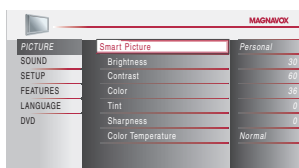

- 4 Adjust the picture quality.

Smart Picture

Use [Cursor ▲/▼] to select the desired setting, then press [OK]. ("Personal", "Standard", "Sports", "Movie" and "Game")

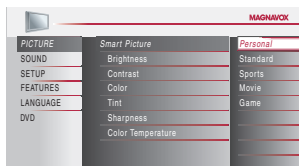

Brightness, Contrast, Color, Tint, Sharpness, Color Temperature

Use [Cursor ▲/▼] to select the desired setting, then use [Cursor ◀/▶] to adjust.

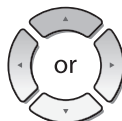

	Cursor ◀	Cursor ▶
Brightness Brightness 30 Adjust Move OK	to decrease brightness	to increase brightness
Contrast Contrast 60 Adjust Move OK	to decrease contrast	to increase contrast
Color Color 36 Adjust Move OK	to decrease color intensity	to increase color intensity
Tint Tint 0 Adjust Move OK	to add red	to add green
Sharpness Sharpness 0 Adjust Move OK	to make soft	to make clear
Color Temperature Color Temp. Normal Adjust Move OK	to add warm colors	to add cool colors

- 5 Press [MENU] to exit.



Note:

- To cancel picture adjustment, press [MENU].

✓ Sound Adjustment

You can adjust the smart sound, equalizer and some other sound functions.

Before you begin: You must set "Home" in "Location" (Refer to page 35). Otherwise, the settings you adjusted will not be memorized after you turn off the unit.

1 Press **[MENU]** to display the main menu.



2 Use **[Cursor ▲/▼]** to select "SOUND", then press **[OK]**.

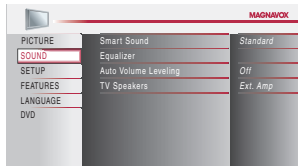

3 Use **[Cursor ▲/▼]** to select the sound type you want to adjust, then press **[OK]**.

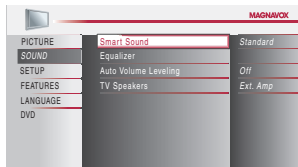

4 Adjust the following items.

Smart Sound

Use **[Cursor ▲/▼]** to select the desired setting, then press **[OK]**. ("Personal", "Standard", "Movie", "Music" and "News")

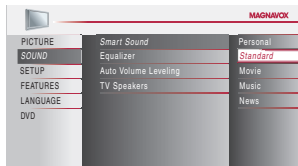

Equalizer

Adjust tonal quality for each frequencies. Use **[Cursor ◀/▶]** to select the specific frequency and use **[Cursor ▲/▼]** to adjust the level, then press **[OK]**.

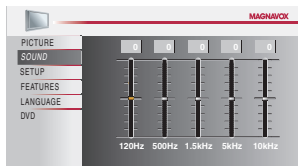
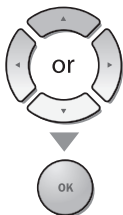

Auto Volume Leveling

This function keeps a constant loudness differential between the TV commercials and the programs.

Use **[Cursor ▲/▼]** to select the desired option, then press **[OK]**.

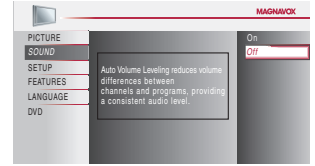

On	Select if you want to reduce volume differences between the TV commercials and the programs.
Off	Select if you want to remove the auto volume leveling.

TV Speakers

Select the audio output from the unit's speakers, or not. If your amplifier compatible with the CEC function is connected to this unit using an HDMI cable, some part of the sound operations such as volume up can access synchronized by using this unit's remote control.

Use **[Cursor ▲/▼]** to select the desired option, then press **[OK]**.

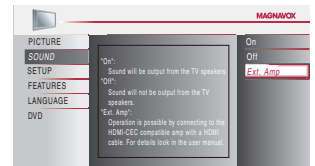

On	The sound will be output from the unit's speakers.
Off	The sound will not be output from the unit's speakers.
Ext. Amp	This function allows you to control audio output from CEC-compatible devices with the unit's remote control.

5 Press **[MENU]** to exit.



Note:

- To cancel sound adjustment, press **[MENU]**.
- We do not guarantee 100% interoperability with other brands of CEC compliant devices.

✓ Closed Caption

You can view closed captioning (CC) for TV programs, movies and news. Closed caption refers to text of dialogue or descriptions displayed on-screen.

- 1 Press **[MENU]** to display the main menu.



- 2 Use **[Cursor ▲/▼]** to select "FEATURES", then press **[OK]**.

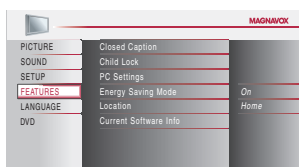

- 3 Use **[Cursor ▲/▼]** to select "Closed Caption", then press **[OK]**.

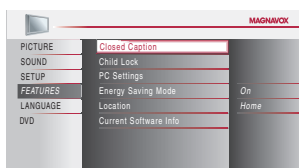

See the following description for setting each item.

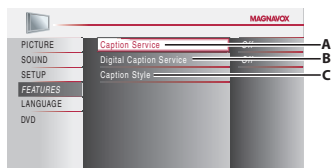

- A... "A. Caption Service" ⇒ page 27
- B... "B. Digital Caption Service" ⇒ page 28
- C... "C. Caption Style" ⇒ page 28

A. Caption Service

- 4 Use **[Cursor ▲/▼]** to select "Caption Service", then press **[OK]**.

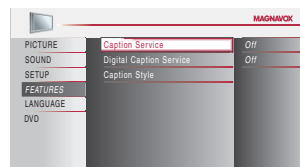

- 5 Use **[Cursor ▲/▼]** to select the desired closed caption, then press **[OK]**.

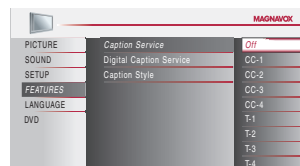

Caption mode

CC-1 and T-1;

are the primary caption and text services.

The captioning or text is displayed in the same language as the program's dialogue (up to 4 lines of script on the TV screen, where it does not obstruct relevant parts of the picture).

CC-3 and T-3;

serve as the preferred data channels.

The captioning or text is often a secondary language.

CC-2, CC-4, T-2 and T-4;

are rarely available and broadcasters use them only in special conditions, such as when "CC-1" and "CC-3" or "T-1" and "T-3" are not available.

- There are 3 display modes according to programs:

Paint-on mode:

Displays input characters on the TV screen immediately.

Pop-on mode:

Once characters are stored in memory, they are displayed all at once.

Roll-up mode:

Displays the characters continuously by scrolling (max. 4 lines).

- 6 Press **[MENU]** to exit.



B. Digital Caption Service

DTV

In addition to the basic closed caption described on page 27, DTV has its own closed caption called digital caption service. Use this menu to change the settings for digital caption service.

- 4 Use [Cursor ▲/▼] to select "Digital Caption Service", then press [OK].

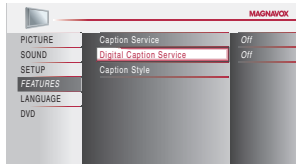

- 5 Use [Cursor ▲/▼] to select the desired digital caption service, then press [OK].

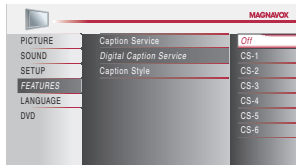

Off	Select if you do not want digital caption service. This is the default.
CS-1 to CS-6	Select one of these before changing any other item in "Closed Caption" menu. Choose "CS-1" under normal circumstances.

- 6 Press [MENU] to exit.



Note:

- "Digital Caption Service" that you can switch differs depending on the broadcast description.

C. Caption Style

DTV

You can change the caption style such as font, color or size, etc.

- 4 Use [Cursor ▲/▼] to select "Caption Style", then press [OK].

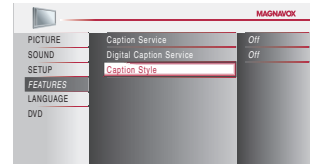

- 5 Use [Cursor ▲/▼] to select "User Setting", then press [OK].

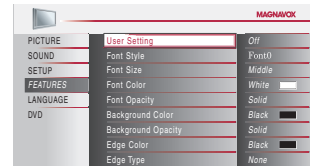

- 6 Use [Cursor ▲/▼] to select "On", then press [OK].

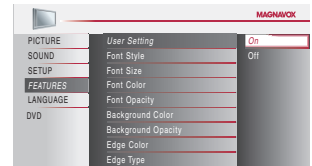

- 7 Use [Cursor ▲/▼] to select an item, then press [OK]. Then use [Cursor ▲/▼] to select the desired setting and press [OK].

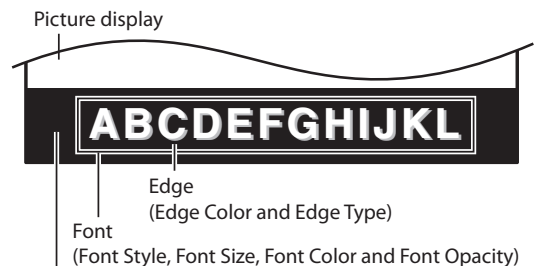

- The setting description for each item is shown on the next page.

Font Style

Closed Captioning font style can be changed as below.

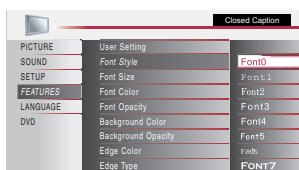

Font Size

Font size of the displayed caption can be switched as below.

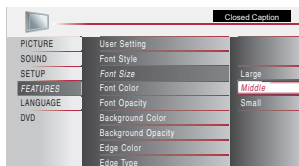

Font Color

Font color of the displayed caption can be switched as below.

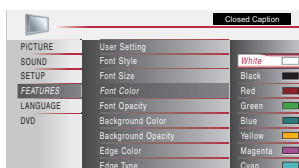

Font Opacity

Font opacity of the displayed caption can be switched as below.

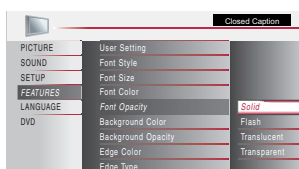

Background Color

Background color of the displayed caption can be switched as below.

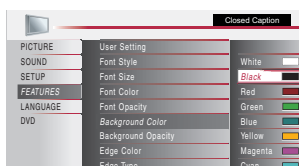

Background Opacity

Background opacity of the displayed caption can be switched as below.

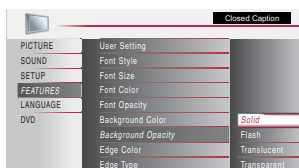

Edge Color

Edge color of the displayed caption can be switched as below.

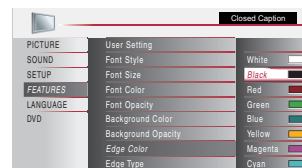

Edge Type

Edge type of the displayed caption can be switched as below.

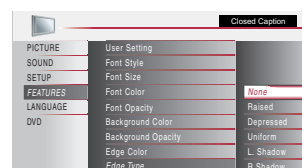

8 Press [MENU] to exit.



Note:

- To show the closed caption on your TV screen, broadcast signal must contain the closed caption data.
- Not all TV programs and commercials have the closed caption or all types of the closed caption.
- Captions and texts may not match the TV voice exactly.
- Changing channels may delay the closed caption for a few seconds.
- Adjusting or muting the volume may delay the closed caption for a few seconds.
- Abbreviations, symbols and other grammatical shortcuts may be used in order to keep pace with the on-screen action. This is not a malfunction.
- The caption or text characters will not be displayed while the main menu or functions display is shown.
- If a black box appears on the TV screen, this means that the closed caption is set to the text mode. To clear the box, select "CC-1", "CC-2", "CC-3", "CC-4" or "Off".
- If the unit receives poor quality television signals, the captions may contain errors, or there might be no captions at all. Some possible causes of poor quality signals are:
 - Automobile ignition noise
 - Electric motor noise
 - Weak signal reception
 - Multiplex signal reception (ghosts or screen flutter)
- The unit retains the closed caption setting if the power fails.
- Closed caption will not be displayed when you are using an HDMI connection.
- When the unit receives special effects playback signal (i.e., Search, Slow and Still) from a VCR's video output channel (CH3 or CH4), the unit may not display the correct caption or text.

✓ Child Lock

Child lock reads the ratings for programs, then denies access to the programs which exceed the rating level you set. With this function, you can block certain programs inappropriate for children and any channels or external input modes can be invisible.

1 Press **[MENU]** to display the main menu.



2 Use **[Cursor ▲/▼]** to select "FEATURES", then press **[OK]**.

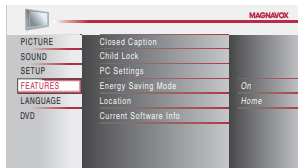

3 Use **[Cursor ▲/▼]** to select "Child Lock", then press **[OK]**.

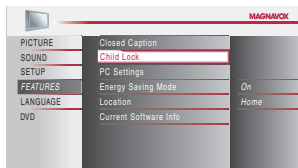

4 Use **[the Number buttons]** to enter the 4-digit numbers for your PIN Code.

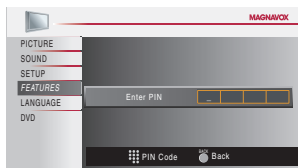
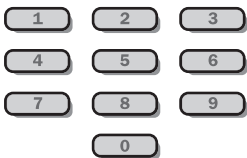

- When you have not set up your PIN Code, enter 0000.
- When the PIN Code is correct, "Child Lock" menu is displayed.

See the following description for setting each item.

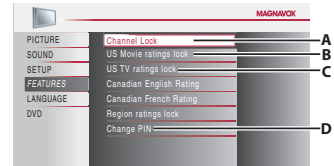

A... "A. Channel Lock" ⇨ page 31

B... "B. US Movie ratings lock" ⇨ page 31

C... "C. US TV ratings lock" ⇨ page 32

D... "D. Change PIN" ⇨ page 33

Note:

- When you select a rating and set it to "Block", the higher ratings will be blocked automatically. The lower ratings will be available for viewing.
- When you set the highest rating to "View", all ratings turn to "View" automatically.
- To block any inappropriate programs, set your limits in "US Movie ratings lock", "US TV ratings lock" and "Region ratings lock".
- The child lock setting will be retained after a power failure (except the access code reverts to 0000).
- If the rating is blocked, will appear.
- "Region ratings lock" will be available when the unit receives a digital broadcast using the new rating system.
- If the broadcasting signal does not have the region ratings lock information, "Region ratings lock is currently not available." will appear. This message will also appear when you try to access "Region ratings lock" after you have cleared the region ratings lock information, and the new information has not been downloaded since.
- The Canadian rating systems on this unit is based on CEA-766-A and the Canadian Radio-Television and Telecommunications Commission (CRTC) policy.

A. Channel Lock

Particular channels or external input modes can be invisible in this function.

- 5 Use [**Cursor ▲/▼**] to select “Channel Lock”, then press [**OK**].

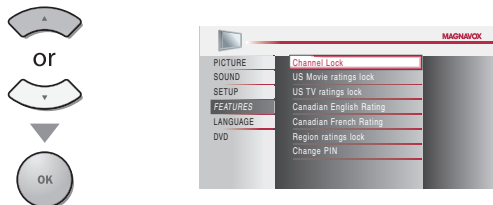

- 6 Use [**Cursor ▲/▼**] to select the desired rating, then press [**OK**] repeatedly to switch between “View” and “Block”.

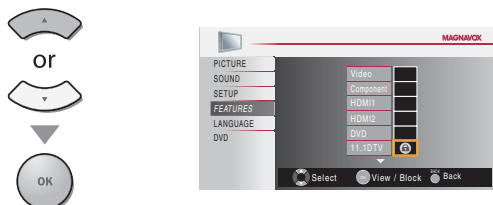

- 7 Press [**MENU**] to exit.



B. US Movie ratings lock

US Movie ratings lock is the rating system created by MPAA (Motion Picture Association of America).

- 5 Use [**Cursor ▲/▼**] to select “US Movie ratings lock”, then press [**OK**].

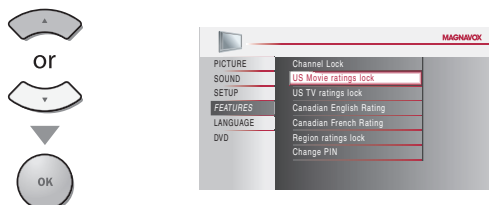

- 6 Use [**Cursor ▲/▼**] to select the desired rating, then press [**OK**] repeatedly to switch between “View” and “Block”.

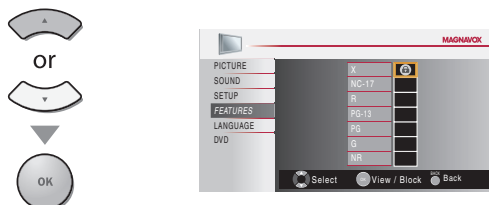

Rating	Category
X	Mature audience only
NC-17	No one under 17 admitted
R	Restricted; under 17 requires accompanying parent or adult guardian
PG-13	Unsuitable for children under 13
PG	Parental guidance suggested
G	General audience
NR	No rating

- 7 Press [**MENU**] to exit.



C. US TV ratings lock

5 Use [Cursor ▲/▼] to select "US TV ratings lock", then press [OK].

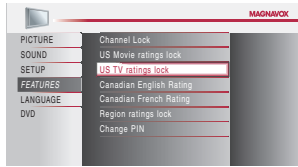

6 Use [Cursor ▲/▼/◀/▶] to select the desired rating, then press [OK] repeatedly to switch between "View" and "Block".

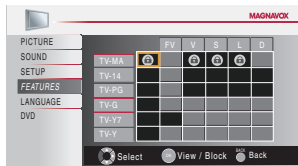
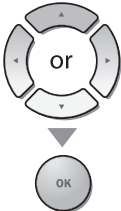

7 Press [MENU] to exit.



To Set the Sub Ratings

As for TV-MA, TV-14, TV-PG, or TV-Y7, you can further set the sub ratings to block specific elements of programming. To set the sub ratings, follow the step below.

Use [Cursor ▲/▼/◀/▶] to select the desired rating, then press [OK] repeatedly to switch between "View" and "Block".

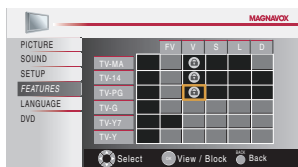
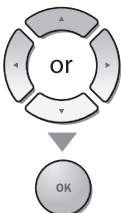

Rating	Category	
TV-MA	Mature audience only	higher ↑ ↓ lower
TV-14	Unsuitable for children under 14	
TV-PG	Parental guidance suggested	
TV-G	General audience	
TV-Y7	Appropriate for all children 7 and older	
TV-Y	Appropriate for all children	

Sub Rating	Category	Rating
FV	Fantasy Violence	TV-Y7
V	Violence	TV-PG
S	Sexual Situation	TV-14
L	Coarse Language	TV-MA
D	Suggestive Dialogue	TV-PG, TV-14

Note:

- Blocked sub rating will appear beside the main rating category in "US TV ratings lock" menu.
- You cannot block a sub rating (D, L, S or V) if the main rating is set to "View".
- Changing the category to "Block" or "View" automatically changes all its sub ratings to the same ("Block" or "View").

D. Change PIN

Although the default code "0000" is supplied with the unit, you can set your own PIN Code.

- 5 Use [Cursor ▲/▼] to select "Change PIN", then press [OK].

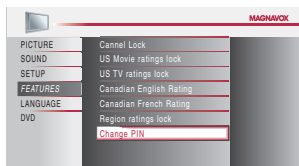

- 6 Press [the Number buttons] to enter the new 4-digit PIN Code.
 • Enter PIN Code again in "Confirm PIN" entry field.

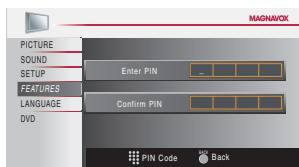
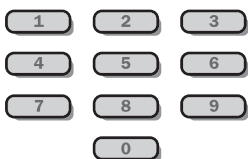

- 7 Press [MENU] to exit.



Note:

- Make sure new PIN Code and confirm PIN Code must be exactly the same. If they are different, the space is cleared for reentering.
- Your PIN Code will be erased and return to the default (0000) when a power failure occurs. If you forget the PIN Code, unplug the AC power cord for 10 seconds to restore the PIN Code to 0000.

✓ PC Settings

This function lets you adjust the PC screen position during PC input through the HDMI 1 input jack.

1 Press **[MENU]** to display the main menu.



2 Use **[Cursor ▲/▼]** to select "FEATURES", then press **[OK]**.

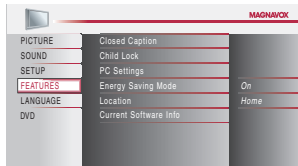

3 Use **[Cursor ▲/▼]** to select "PC Settings", then press **[OK]**.

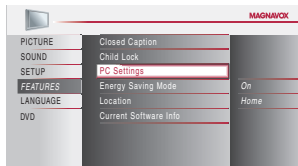

4 Use **[Cursor ▲/▼]** to select the setting you want to adjust, then press **[OK]**.

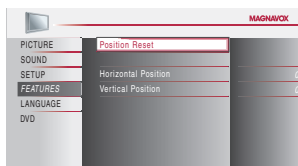

5 Adjust the setting.

Position Reset

Use **[Cursor ▲/▼]** to select "Reset", then press **[OK]**.



- The horizontal/vertical position of the PC screen are automatically adjusted.

Horizontal Position, Vertical Position

Use **[Cursor ◀▶]** to adjust.

	Cursor ◀	Cursor ▶
Horizontal Position 	to move PC screen left	to move PC screen right
Vertical Position 	to move PC screen down	to move PC screen up

6 Press **[MENU]** to exit.



Note:

- You may not obtain an appropriate screen with "Position Reset" for some signals. In this case, adjust the settings manually.

✓ Energy Saving Mode

You can set whether the power consumption is saved or not.

- 1 Press **[MENU]** to display the main menu.



- 2 Use **[Cursor ▲/▼]** to select "FEATURES", then press **[OK]**.

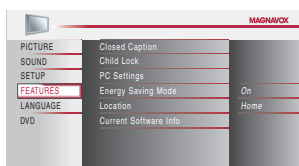

- 3 Use **[Cursor ▲/▼]** to select "Energy Saving Mode", then press **[OK]**.

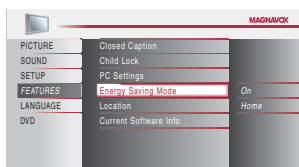

- 4 Use **[Cursor ▲/▼]** to select the desired mode, then press **[OK]**.



On	Select if you want to reduce the power consumption.
Off	The power consumption may possibly exceed the limited requirement of the ENERGY STAR® qualification.

- 5 Press **[MENU]** to exit.



✓ Location

When you select "Retail", the power consumption may possibly exceed the limited requirement of the ENERGY STAR® qualification.

- 1 Press **[MENU]** to display the main menu.



- 2 Use **[Cursor ▲/▼]** to select "FEATURES", then press **[OK]**.

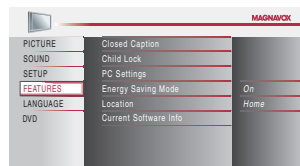

- 3 Use **[Cursor ▲/▼]** to select "Location", then press **[OK]**.

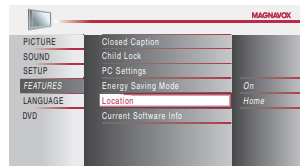

- 4 Use **[Cursor ▲/▼]** to select the desired location, then press **[OK]**.

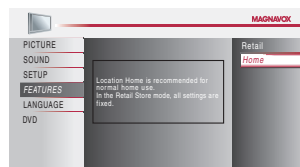

- 5 Press **[MENU]** to exit.



☑ **Current Software Info**

This function shows what version of the software currently used.

1 Press **[MENU]** to display the main menu.



2 Use **[Cursor ▲/▼]** to select "FEATURES", then press **[OK]**.

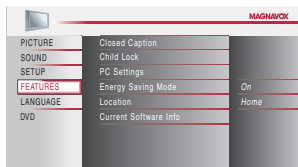

3 Use **[Cursor ▲/▼]** to select "Current Software Info", then press **[OK]**.

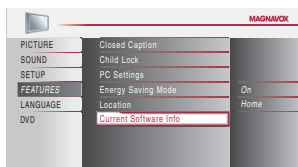

4 Confirm the version of the software currently used.











5 Press **[MENU]** to exit.



DVD Functions

✓ Playable Media

Media Type	DVD-VIDEO	DVD-RW	DVD-R	DVD+RW	DVD+R	CD-DA	CD-RW	CD-R
Logo								
Recorded Signal	digital video (MPEG2)					digital audio		
Media Size	5 inches (12 cm)							

✓ Unplayable Media

NEVER play back the following discs. Otherwise, malfunction may result!

3 inch (8 cm) disc, DVD-RAM, DVD-audio, CD-i, photo CD, Video CD, DVD with region codes other than 1 or ALL, DTS-CD, DVD-ROM for personal computers, CD-ROM for personal computers, the discs with labels, scratches, stains, blemishes, etc., HD DVD, Blu-ray Disc, CD-RW/-R with MP3 files and CD-RW/-R with JPEG files including Kodak Picture CD.

On the following disc, the sound MAY NOT be heard.

super audio CD

Any other discs without compatibility indications

Note:

- Unfinalized discs cannot be played back.
- For DVD-RW/R, discs recorded in the VR (video recording) format cannot be played back. Only the finalized video format discs can be played back.
- Some discs cannot be played back because of incompatible recording conditions, characteristics of the recorder or special properties of discs.
- Only the sound recorded on the normal CD layer can be delivered. The sound recorded on the high density super audio CD layer cannot be delivered.
- Do not use a single CD adaptor which makes 3 inch (8 cm) to 5 inch (12 cm) disc.
- You can play back discs with the marks listed in "Playable Media". If you use non-standardized discs, this unit may not play them back or the sound and video quality will be compromised.
- If the recorded portion of the disc is too small (less than 2-3/16 inches (55 mm) across), it may not play back properly.

Region Codes

This unit has been designed to play back DVD with region 1. DVD must be labeled for ALL regions or for region 1 in order to play back on the unit. You cannot play back DVD that are labeled for other regions. Look for the symbols on your DVD. If these region symbols are not on your DVD, you cannot play back the DVD in this unit.



The number inside the globe refers to region of the world. A DVD labeled for a specific region can only be played back on the unit with the same region code.

Color Systems

DVD is recorded in different color systems throughout the world. The most common color system is NTSC (which is used primarily in the United States and Canada).

This unit uses NTSC, so DVD you play back must be recorded in the NTSC system. You cannot play back DVD recorded in PAL color systems.

These operations are accessible by remote control. Some may also be accessible by controls on the main unit.

✓ Playback

Before you begin:

Turn on the amplifier and any other equipment which is connected to this unit. Make sure the external audio receiver (not included) are set to the correct channel.

- 1 Press **[POWER]** to turn on the unit.



- 2 Insert a disc with label facing forward.



- In case the DVD was recorded on both sides, make sure the label of the side you want to play back is facing forward.

- 3 The unit switches to the DVD mode when the unit was in TV mode and detects the type of disc.

e.g.) DVD

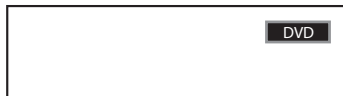

- Press **[PLAY ▶]** if the unit does not go to the DVD mode.

- 4 The unit starts playback.

- If playback does not start automatically, press **[PLAY ▶]** again.

- 5 Press **[STOP ■]** to stop playback temporarily.



- If playback remains stopped for 20 minutes, the unit will turn itself off automatically when "AUTO POWER OFF" is set to "ON".

- 6 Press **[EJECT ▲]** to eject the disc.



Note:

- "⊘" may appear at the top-right on the TV screen when the operation is prohibited by the disc or this unit.
- Some DVD may start playback from title 2 or 3 due to specific programs.
- During the playback of a 2-layered disc, pictures may stop for a moment. This happens while the 1st layer is being switched to the 2nd layer. This is not a malfunction.
- When you cannot remove the disc, you may try either following operations.
 - Press and hold **[EJECT ▲]** on the unit for more than 5 seconds.
 - Unplug the AC power cord and plug it in again, then press **[EJECT ▲]**.
 It will take about 10 seconds to eject the disc, while that the unit will not respond to any key commands.

✓ Disc Menu

DVD

Some discs contain disc menus which describe the contents of the disc or allow you to customize disc playback, or title menu which lists the titles available on the DVD.

To display the DVD menu, press **[DISC MENU]** and use **[Cursor ▲ / ▼ / ◀ / ▶]** to select an item, then press **[OK]** (or **[PLAY ▶]**).

To display the top menu, press **[TITLE]** and use **[Cursor ▲ / ▼ / ◀ / ▶]** to select an item, then press **[OK]** (or **[PLAY ▶]**).

Note:

- Menu operations may vary depending on the disc. Refer to the manual accompanying the disc for more details.

✓ Resume Playback

Press **[STOP ■]** during playback. Resume message will appear on the TV screen.

Press **[PLAY ▶]**. Playback will resume from the point at which playback was stopped.

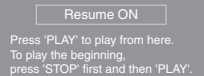

Note:

- To cancel resume, press **[STOP ■]** one more time in the stop mode. On some discs, **[STOP ■]** will not work while the resume message appears. Please wait until the message disappears.
- The resume information will be kept even when the unit is turned off. However, ejecting the disc will cancel the resume feature. Playback will start at the beginning the next time you insert the disc.

✓ Paused and Step-by-step Playback

Press **[PAUSE ■■]** during playback.

- Playback will be paused and sound will be muted.

To continue playback, press **[PLAY ▶]**.

DVD

Each time you press **[PAUSE ■■]** in the pause mode, the disc goes forward one frame at a time.

To continue playback, press **[PLAY ▶]**.

Note:

- Set "STILL MODE" to "FIELD" in the "OTHERS" menu if pictures in the pause mode are blurred. (Refer to page 49.)

✓ Fast Forward / Fast Reverse

Press **[FWD ►►]** or **[REV ◀◀]** repeatedly during playback to select the desired forward or reverse speed.



To continue playback, press **[PLAY ►]**.

Note:

- Set "STILL MODE" to "FIELD" in the "OTHERS" menu if pictures in the fast playback mode are blurred. (Refer to page 49.)
- Fast forward / fast reverse speed varies with disc. Approximate speed is 1(2x), 2(8x), 3(20x), 4(50x) and 5(100x) on DVD and 1(2x), 2(8x) and 3(30x) on audio CD.
- For DVD, sound will be muted during this function.
- For audio CD, sound will be intermittent during the search.

✓ Slow Forward / Slow Reverse

DVD

Press **[FWD ►►]** or **[REV ◀◀]** repeatedly during the paused mode to select the desired forward or reverse speed.



To continue playback, press **[PLAY ►]**.

Note:

- Set "STILL MODE" to "FIELD" in the "OTHERS" menu if pictures in the slow playback mode are blurred. (Refer to page 49.)
- Slow forward / slow reverse speed varies with disc. Approximate speed is 1(1/16x), 2(1/8x) and 3(1/2x).
- The sound will be muted during this function.

✓ Zoom

DVD

The zoom function allows you to enlarge the video image and to pan through the enlarged image.

- 1 During playback, press **[MODE]** repeatedly until "OFF (ZOOM)" appears.

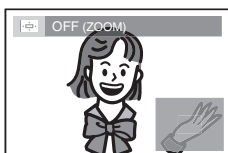

- The picture becomes twice as large.

- 2 Press **[OK]** repeatedly to change the zoom factor, "2x" or "4x".

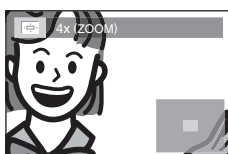

- 3 Once a desired zoom factor is set, use **[Cursor ▲ / ▼ / ◀ / ▶]** to slide the zoomed picture across the TV screen.

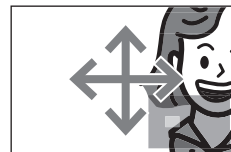
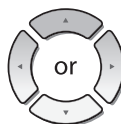

- 4 To exit zoom, repeat steps 1 to 2 above and press **[OK]** repeatedly until "OFF" appears.



Note:

- The gray box with an inner blue box that shows during zoomed playback is the position guide indicates the position of the zoomed image within the overall image. Position guide stays on the TV screen until you press **[OK]**. Press **[OK]** one more time to recall the position guide when disappears.
- Zoom function does not work while the disc menu is displayed.
- 4x zoom is not available on some discs.
- Zoom function is also available during pause mode.

✓ Search Functions

Chapter / Title / Track Search

You can select chapters, titles or tracks on the disc.

- 1 During playback, press [MODE] repeatedly until "CH" / "TR" appears.
 - If you want to perform the title search, use [Cursor ▲ / ▼] repeatedly until "TT" appears.

e.g.) DVD



- 2 Press [the Number buttons] to select your desired chapter, title or track within 60 seconds.

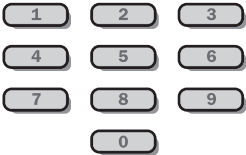

To play back a single-digit chapter, title or track when there are more than 10 chapters, titles or tracks, press [OK] after entering the chapter, title or track number.

- 3 Playback will start automatically from the chapter, title or track you selected.

Note:

- Chapter, title or track search can only be performed during playback or when the unit has kept the resume information. It cannot be performed in the stop mode.
- The total number of chapters / titles / tracks in your disc; with less than 10 chapters / titles / tracks, press the chapter / title / track number directly. To play a double-digit chapter / title / track, press the chapter / title / track number.
- Track search is not available for programmed or random playback.

Using [SKIP |◀◀, ▶▶|]

- 1 During playback, press [SKIP |◀◀, ▶▶|] repeatedly until a desired chapter, title or track will be selected.

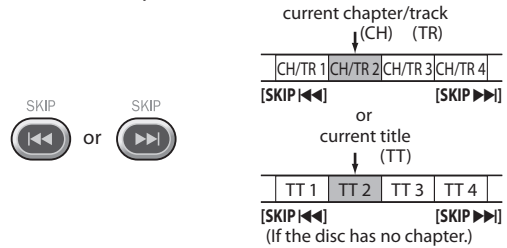

- 2 Playback will start automatically from the chapter, title or track you selected.

Note:

- [SKIP |◀◀, ▶▶|] are not available when playback is stopped.

Time Search

You can select the desired time which the disc is played back from.

- 1 During playback, press **[MODE]** repeatedly until "CH" / "TR" appears.



- 2 Use **[Cursor ▲ / ▼]** repeatedly until "C" appears.



- 3 Press **[the Number buttons]** to select your desired time lapse within 60 seconds.

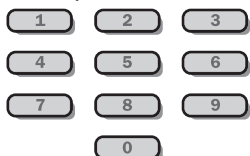

- 4 Playback will start automatically from the time you selected.

Note:

- When there is no need to enter a number, "0" appears automatically. For example, "0:0:_" appears in the time search menu if the total time of the title or track is less than 10 minutes.
- Press **[CLEAR]** to erase the incorrect input at step 3.
- Time search can only be performed during playback or when the unit has kept the resume information. It cannot be performed in the stop mode.

Direct Search

Press **[the Number buttons]** to select your desired chapter, title or track.

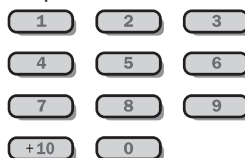

Note:

- To select a single-digit chapter, title or track number, press the number directly.
- To select double digit chapter, title or track number:
 - If the disc contains more than 9 and less than 100 chapter, title or track, press **[+10]** first, then enter the double digit chapter, title or track number.
 - (e.g., for track 26, press **[+10]**, **[2]** and **[6]**.)

Repeat Playback

Repeat function is available only during playback.

- 1 During playback, press **[MODE]** repeatedly until "C" appears.



- 2 Press **[Cursor ▲ / ▼]** to change the repeat mode.

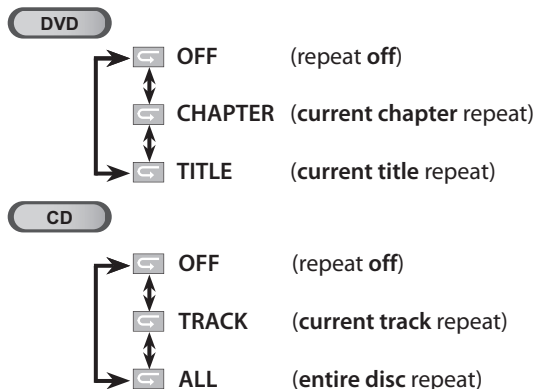

- 3 Press **[BACK]** to exit.



Repeat A-B Playback

You can repeat playback between A and B on a disc.

- 1 During playback, press **[MODE]** repeatedly until "A-B" appears.



- 2 Press **[OK]** at your desired starting point (A).



- 3 Press **[OK]** at your desired ending point (B).



- Point B should be in the same title or track as point A.
- Within a few seconds, the section A-B will begin to play back repeatedly.

- 4 To cancel repeat A-B playback, press **[MODE]** repeatedly until "A-B" appears. Press **[OK]** so "OFF" appears.



Note:

- Repeat setting (except "ALL") will be cleared when moving to another title or chapter, track.
- During programmed playback, repeat setting will be effective for the tracks in the program.
- Repeat playback or repeat A-B playback may not available with some discs.
- Repeat A-B playback does not function during other repeat mode.
- To cancel point A, press **[CLEAR]** at step 2 in "Repeat A-B Playback".
- Stopping playback will cancel repeat A-B playback.

Random Playback

CD

This function shuffles the playing order of tracks instead of playback in the sequence.

- 1 In stop mode, press **[MODE]** repeatedly until "RANDOM" menu appears.

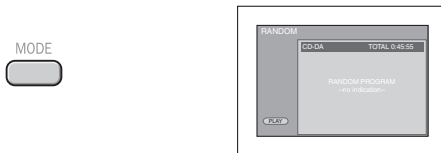

- 2 Press **[PLAY ▶]** to start random playback.



Note:

- To repeat the current track in the random mode, follow the steps 1 and 2 in "Repeat Playback" on page 41 and select "TRACK".
- To repeat the entire random selections, follow the steps 1 and 2 in "Repeat Playback" on page 41 and select "ALL".

Programmed Playback

CD

You may determine the order in which tracks will play back.

- 1 In stop mode, press **[MODE]** repeatedly until "PROGRAM" menu appears.

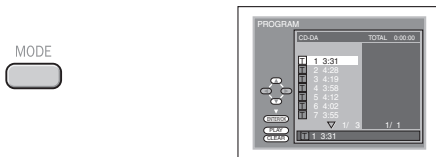

- 2 Use **[Cursor ▲ / ▼]** to select a desired track, then press **[OK]** to store.

- Additional tracks may be on other screens. Use **[Cursor ▲ / ▼]** to go on to the next / previous pages.
- Repeat this step until you have selected all the tracks you wish to play back in the program.

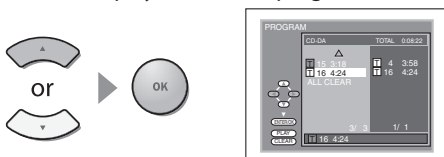

- Up to 99 tracks can be ordered.
- If 8 or more tracks were in a program, use **[SKIP ◀◀ / ▶▶]** to see all the tracks.

- 3 Press **[PLAY ▶]** to start programmed playback.



Note:

- Press **[CLEAR]** to erase the last track in the program if you make an error.
- To erase all programmed tracks at once, select "ALL CLEAR" and press **[OK]** at step 2.
- While a program is being played back, **[STOP ■]** works as follows:
 - Pressing **[STOP ■]** once: The track will be in the resume standby mode. Next time you press **[PLAY ▶]**, the playback will resume from the point where it is stopped in the programmed playback.
 - Pressing **[STOP ■]** twice: Resume mode will be canceled. Next time you press **[PLAY ▶]**, playback will restart from the first track in the original order. However, your programmed playback can be restarted when you follow the above steps. (Your programs are still stored until either the disc is ejected or the unit is turned off.)
 - On some discs, **[STOP ■]** will not work while the resume message appears. Please wait until the message disappears.
- To repeat the current track in the program, follow the steps 1 and 2 in "Repeat Playback" on page 41 and select "TRACK".
- To repeat the entire program, follow the steps 1 and 2 in "Repeat Playback" on page 41 and select "ALL".
- Turning off the unit or ejecting the disc will erase the program.
- You cannot use **[the Number buttons]** to select another track during programmed playback. Use **[SKIP ◀◀ / ▶▶]** to select other tracks in the program.
- You cannot combine random playback with programmed playback.
- You cannot alter a programmed order during playback.
- You can start programmed playback only while in "PROGRAM" menu.

✓ On-screen Display

You can check the information about the current disc by pressing [INFO] on the remote control.

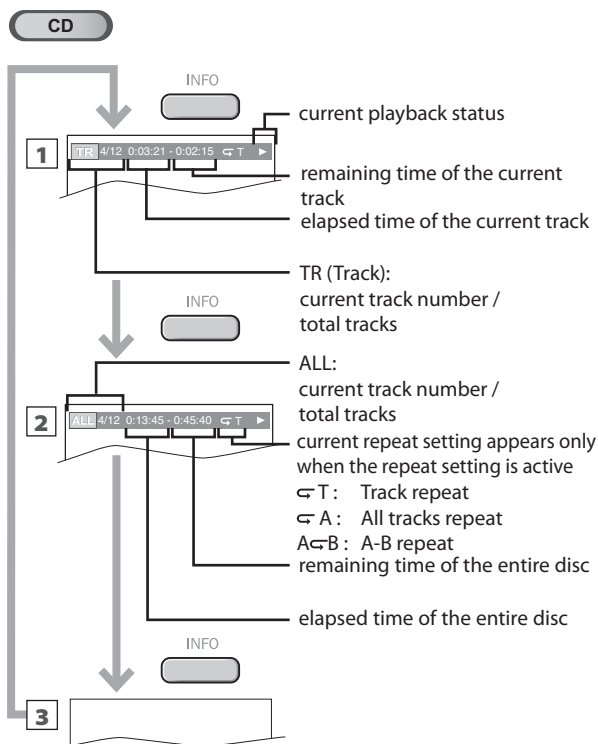
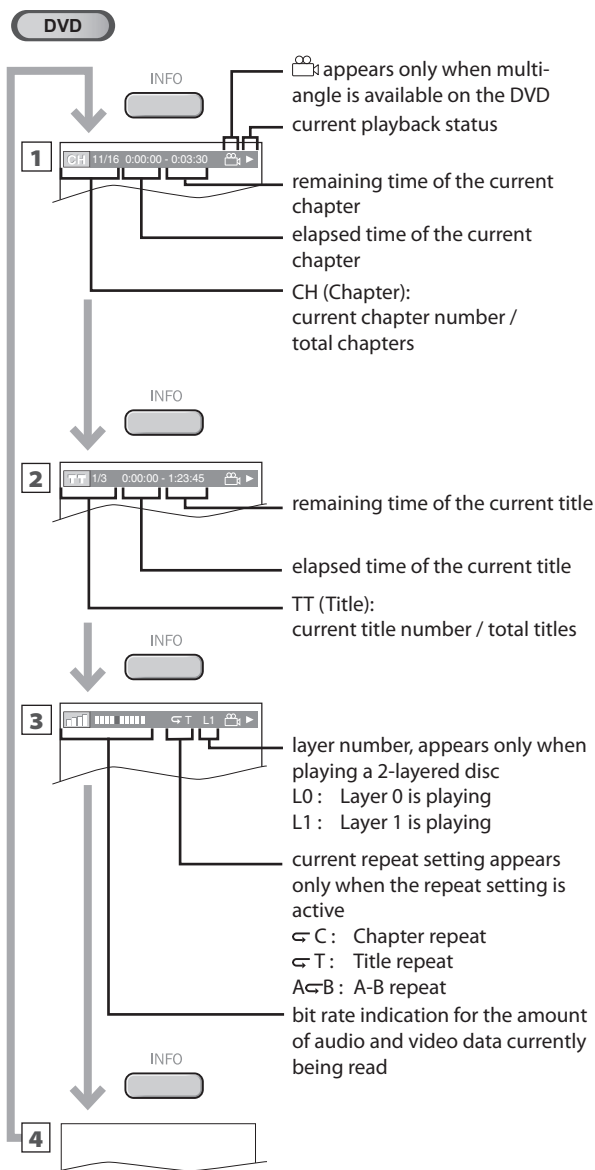

Note:

- When you are playing back an audio CD in program or random mode, "TR PROGRAM" (or "TR RANDOM") will be displayed instead of [2].

✓ Special Settings

Subtitle Language

DVD

This unit allows you to select a subtitle language (if available) during DVD playback.

- During playback, press [MODE] repeatedly until "☐" appears.



- Use [Cursor ▲/▼] repeatedly until your desired language appears.

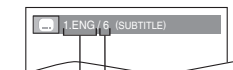

subtitles can be varied on the displayed number.
current subtitles language.

- Each time you press [Cursor ▲/▼], the subtitle language changes as shown on the next page.

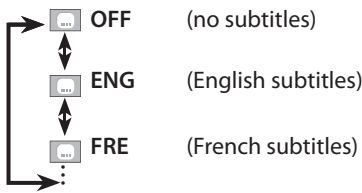

3 Press **[BACK]** to exit.



Note:

- To cancel the subtitle, select "OFF" at step 2.
- If your language is not shown after pressing **[Cursor ▲ / ▼]** several times, the disc may not have that language. However, some discs allow you to change subtitle languages setting in the disc menu. (Operation varies depending on the disc, so refer to the manual along with the disc.)
- When "NOT AVAILABLE" appears on the TV screen, it means no subtitle is recorded on the scene.
- If you choose a language that has 3-letter-language code, the code will be displayed every time you change the subtitle language setting. If you choose any other languages, "----" will be displayed instead. (Refer to page 50.)
- Ejecting the disc will cancel your subtitle setting.

Audio Language

DVD

This unit allows you to select an audio language (if multiple languages are available) during DVD playback.

During playback, press **[SAP/AUDIO]** repeatedly until the desired language appears.

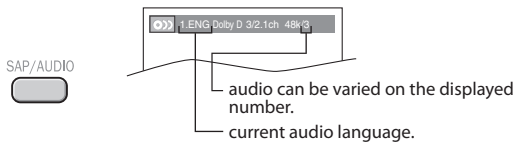

- Each time you press **[SAP/AUDIO]**, the audio language changes as example below.

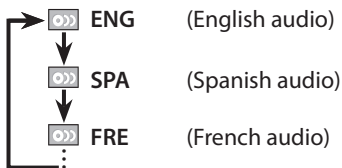

Note:

- Some discs will only allow you to change the audio setting from the disc menu. Refer to the manual accompanying the discs for details.
- If your language is not shown after pressing **[SAP/AUDIO]** several times, the disc may not have that language. However, some discs allow you to change multiple audio languages setting in the disc menu. (Operation varies depending on the disc, so refer to the manual along with the disc.)
- When "NOT AVAILABLE" appears on the TV screen, it means audio language is not available.

Camera Angles

DVD

Some DVD may contain scenes which have been shot simultaneously from various angles. You can change the camera angle if "ANGLE" appears on the screen. If "ANGLE ICON" is set to "OFF" in "OTHERS" menu, "ANGLE" will not appear. (Refer to page 49.)

1 During playback, press **[MODE]** repeatedly until "ANGLE" appears.



2 Use **[Cursor ▲ / ▼]** repeatedly until your desired camera angle appears.

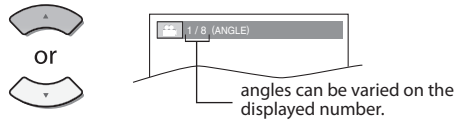

3 Press **[BACK]** to exit.



Black Level Setting

DVD

Adjust the black level to make the dark areas of the TV picture brighter.

1 During playback, press **[MODE]** repeatedly until "BLACK LEVEL" appears.

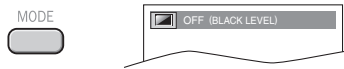

2 Press **[Cursor ▲ / ▼]** to adjust the black level.

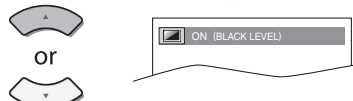

- ON** : Makes the dark areas brighter.
- OFF** : Shows the original picture as recorded.

3 Press **[BACK]** to exit.



Note:

- The setting will be kept even if the unit is turned off.

Stereo Sound Mode

CD

This unit allows you to select a sound mode during CD playback.

During playback, press **[SAP/AUDIO]** repeatedly until the desired sound mode appears.

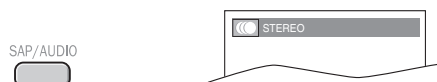

- Each time you press **[SAP/AUDIO]**, the sound mode changes as example below.

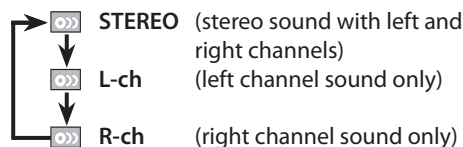

Note:

- Virtual surround cannot be changed when the sound mode is set to either "L-ch" or "R-ch".

Virtual Surround

You can enjoy virtual surround on your 2 channel stereo system.

- During playback, press **[MODE]** repeatedly until "**[OFF]**" appears.

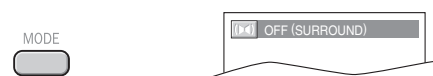

- Press **[Cursor ▲/▼]** to select the sound level.



- 1**: Natural effect.
- 2**: Emphasized effect.
- OFF**: No effects (original sound).

- Press **[BACK]** to exit.



Note:

- The setting will be kept even if the unit is turned off.
- For audio CD, virtual surround will not be effective if the sound mode is set to something other than "STEREO". (Refer to "Stereo Sound Mode" on page 45.)
- Turn down the level or select "OFF" if the sound is distorted.

Marker Setup

This feature allows you to assign a specific point on a disc to be called back later.

To set a marker

- During playback, press **[MODE]** repeatedly until "**[CH]**" / "**[TR]**" appears.



- Use **[Cursor ▲/▼]** repeatedly until marker search menu appears.

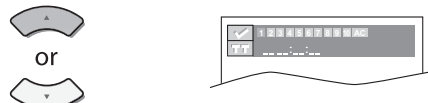

- Use **[Cursor ◀/▶]** to select an available marker within 60 seconds.



- When the playback reaches the point at which you want to set a marker, press **[OK]**.
 - Marker is now set.

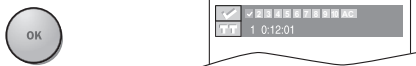

- Press **[BACK]** to exit.



To return to the marker later

- Repeat steps 1-2 in "To set a marker". Use **[Cursor ◀/▶]** to select the desired marker.

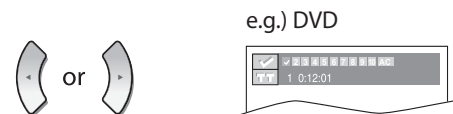

- Press **[OK]** at the desired marker to restart playback from the specific point which you set.



Note:

- Marker search menu will disappear in about 60 seconds when there is no input.
- You can mark up to 10 points.
- To clear a marker, select the marker to be cleared, and then press **[CLEAR]**.
- Ejecting the disc or turning off the power will erase all markers.
- Selecting "**[AC]**" at step 3 in the section "To set a marker" will also erase all markers.

Settings are only effective when the unit is in DVD mode and any discs should not be played back.

✓ DVD Language Setting

You can change the desired language when playing back the disc.

1 Press **[MENU]** to display the main menu.

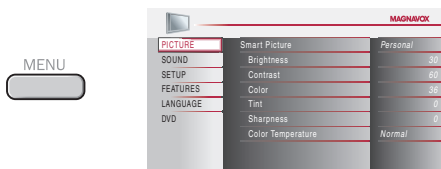

2 Use **[Cursor ▲/▼]** to select "DVD", then press **[OK]**.

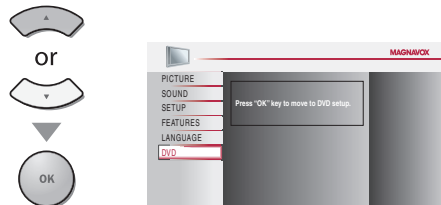

3 Use **[Cursor ◀/▶]** to select "LANGUAGE", then press **[OK]**.

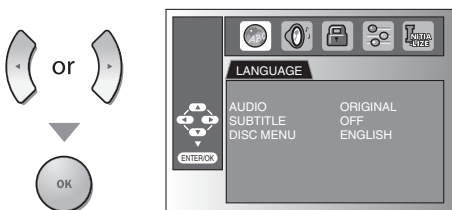

4 Use **[Cursor ▲/▼]** to select the desired item, then press **[OK]**.

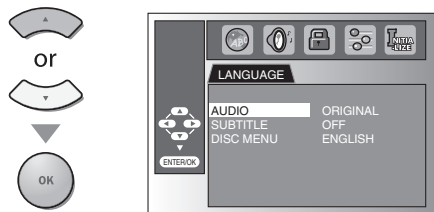

5 Use **[Cursor ▲/▼]** to select the desired item, then press **[OK]**.

AUDIO *1, *2 (Default: ORIGINAL)
Select the desired audio language.

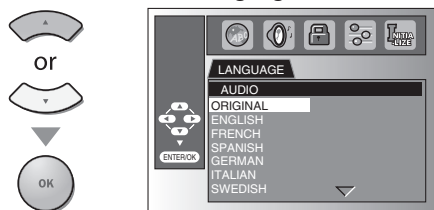

SUBTITLE *1, *2 (Default: OFF)
Select the desired subtitle language.

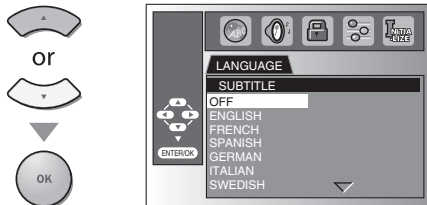

DISC MENU *1 (Default: ENGLISH)
Select the desired language in DVD menu.

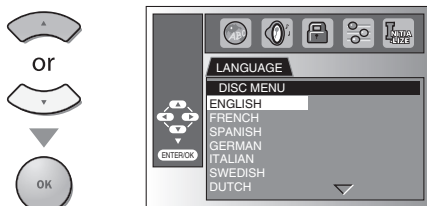

Note:

- To change the on-screen language, call up "LANGUAGE" from the main menu and set the desired language. (Refer to "Language Selection" on page 24.)
- *1**
 - Language options are not available with some discs.
 - If "OTHER" is selected in "AUDIO", "SUBTITLE" or "DISC MENU" menu, press 4-digit number to enter the code for the desired language. (Refer to "Language Code List" on page 50.)
 - Only the languages supported by the disc can be selected.
- *2**
 - Language setting for Audio and Subtitle are not available with some discs.
 - Use **[MODE]** to select subtitles available on the DVD.
 - Use **[SAP/AUDIO]** to select audio available on the DVD.
 - If the DVD's default settings for audio and subtitle are the same language, the subtitles may not show unless you turn them on.

6 Press **[MENU]** to exit.



✓ DVD Audio Setting

Choose the appropriate audio settings for your equipment. It only affects during the playback of DVD.

1 Press **[MENU]** to display the main menu.

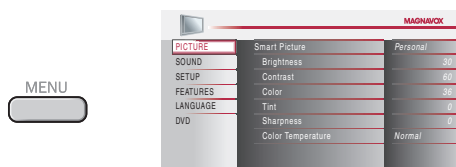

2 Use **[Cursor ▲/▼]** to select "DVD", then press **[OK]**.



3 Use **[Cursor ◀/▶]** to select "DRC", then press **[OK]**.

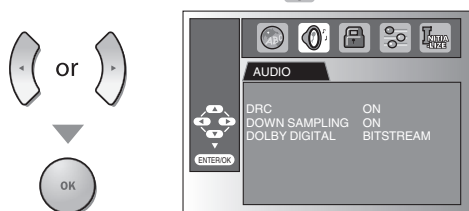

4 Use **[Cursor ▲/▼]** to select the desired item, then press **[OK]**.

DRC (dynamic range control) (Default: ON)

This function is available only on the discs which are recorded in the Dolby Digital format.

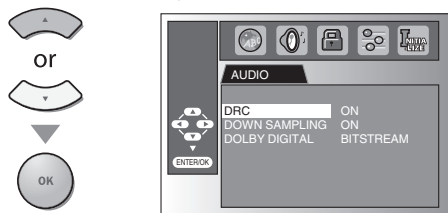

ON : Compress the range between soft and loud sounds.

OFF : No effects (original sound).

DOWN SAMPLING (Default: ON)

This function is available only on digital outputting of a disc recorded in 96kHz.

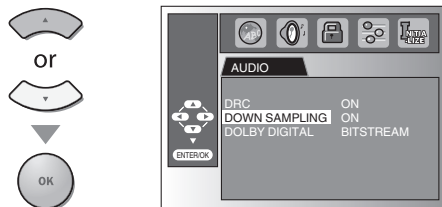

ON : When outputting in 48kHz.

OFF : When outputting the original sound.

Note:

- When playing back a 96 kHz disc with the copyright protection or when "Virtual Surround" is set to "1" or "2", the sound will be down sampled at 48 kHz even if the "DOWN SAMPLING" is set to "OFF". (refer to "Virtual Surround" on page 45)

DOLBY DIGITAL (Default: BITSTREAM)

Set to "BITSTREAM" when this unit is connected to a Dolby Digital decoder.

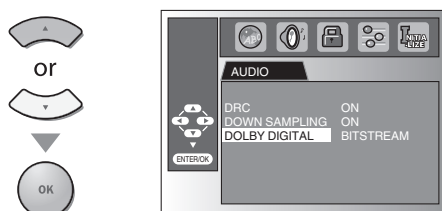

BITSTREAM : Outputs Dolby Digital signals.
PCM : Converts the Dolby Digital into PCM. (2 channel)

5 Press **[MENU]** to exit.



✓ Parental Setting

Parental setting prevents your children from viewing inappropriate materials. (password protected.) Playback will stop if the ratings exceed the levels you set.

1 Press **[MENU]** to display the main menu.

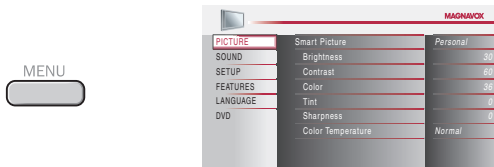

2 Use **[Cursor ▲/▼]** to select "DVD", then press **[OK]**.



3 Use **[Cursor ◀/▶]** to select " ", then press **[OK]**.

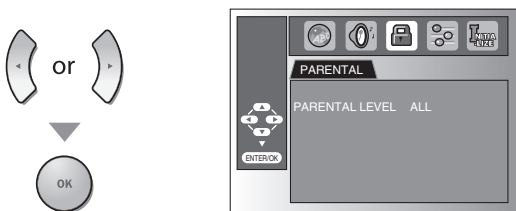

4 Use **[the Number buttons]** to enter the 4-digit numbers for your password, then press **[OK]**.

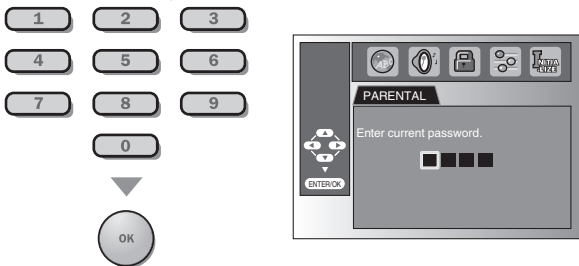

- If you have set password already, use **[the Number buttons]** to enter the current 4-digit password.
- You cannot use the default password (4737) to play back a DVD.

5 Use **[Cursor ▲/▼]** to select the "PARENTAL LEVEL", then press **[OK]**.

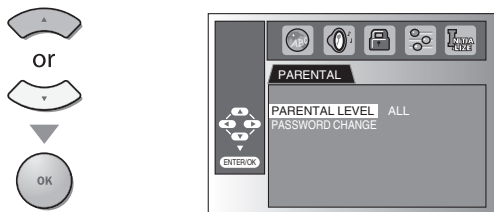

6 Use **[Cursor ▲/▼]** to select the desired item, then press **[OK]**.

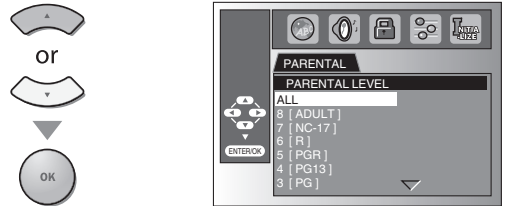

PARENTAL LEVEL

- ALL :** All parental locks are cancelled.
- 8 [ADULT] :** All ratings (adult / general / children) can be played back.
- 7 [NC-17]-2 [G] :** Only DVD intended for general use and children can be played back.
- 1 [KID SAFE] :** Only DVD intended for children can be played back.

7 Press **[MENU]** to exit.



To change the password

5 Follow steps 1 to 4. Use **[Cursor ▲/▼]** to select "PASSWORD CHANGE", then press **[OK]**.

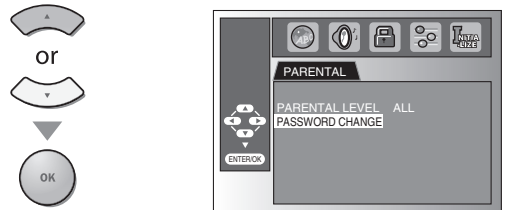

6 Use **[the Number buttons]** to enter the new 4-digit password.

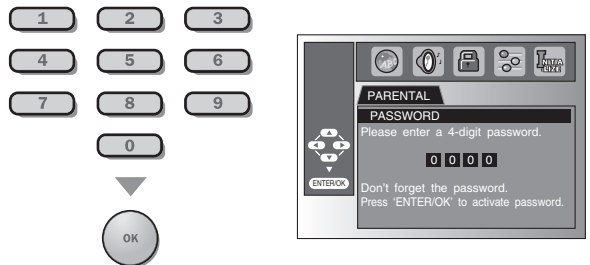

Note:

- DVD-video may not respond to parental lock settings. Make sure this function works with your DVD-video.
- Record the password in case you forget it.
- If you forget the password, press **[4], [7], [3], [7]**, then enter your new password. Password will be cleared and parental levels will be set to "ALL".
- A power failure will not erase your password.

7 Press **[MENU]** to exit.



Others

You can change the other functions.

- 1 Press **[MENU]** to display the main menu.

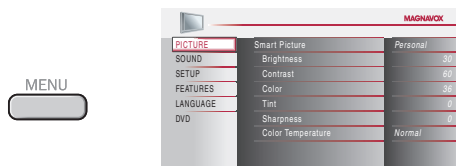

- 2 Use **[Cursor ▲/▼]** to select "DVD", then press **[OK]**.



- 3 Use **[Cursor ◀/▶]** to select "OTHERS", then press **[OK]**.

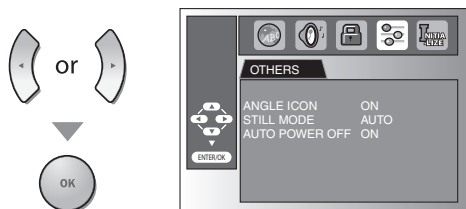

- 4 Use **[Cursor ▲/▼]** to select the desired item, then press **[OK]**.

ANGLE ICON

(Default: ON)

Set to "ON" to show the angle icon when multiple camera angles are available during DVD playback.

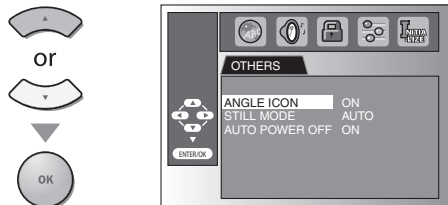

STILL MODE

(Default: AUTO)

Set the picture quality in the still mode.

If you select "AUTO", it automatically selects the best resolution setting ("FRAME" or "FIELD") based on the date characteristics of the pictures.

FIELD : The picture in the still mode will be stabilized.

FRAME : The picture in the still mode will be highly defined.

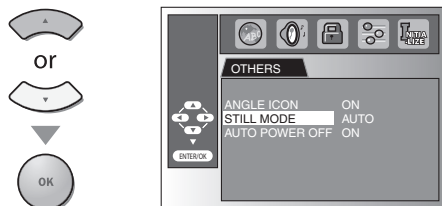

AUTO POWER OFF

(Default: ON)

Set to "ON" to turn this unit off automatically after 20 minutes of no use.

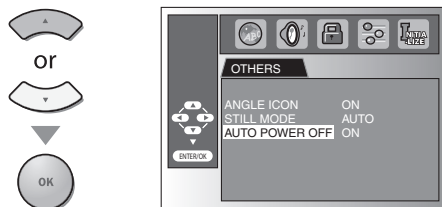

- 5 Press **[MENU]** to exit.



✓ **Reset to the Default Setting**

You can reset all the settings except for the parental setting and on-screen menu language.

1 Press **[MENU]** to display the main menu.

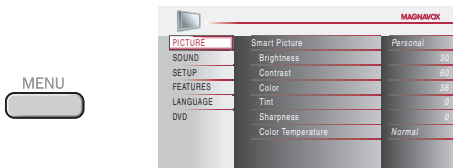

2 Use **[Cursor ▲/▼]** to select “DVD”, then press **[OK]**.

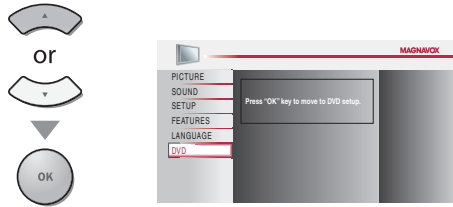

3 Use **[Cursor ◀/▶]** to select “INITIALIZE”, then press **[OK]**.



4 Use **[Cursor ▲/▼]** to select “YES”, then press **[OK]**.

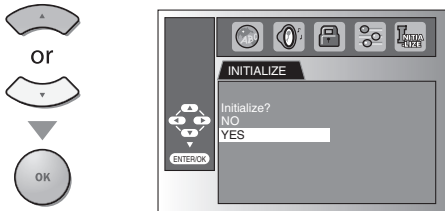

Note:

- When you want to cancel the initialization, select “NO” at step 4, then press **[OK]**.

5 Press **[MENU]** to exit.



✓ **Language Code List**

Language	A-B	Code	Language	Code
Abkhazian		4748	Marathi	5964
Afar		4747	Moldavian	5961
Afrikaans		4752	Mongolian	5960
Albanian		6563	Nauru	6047
Amharic		4759	Nepali	6051
Arabic		4764	Norwegian [NOR]	6061
Armenian		5471		
Assamese		4765	O-R	
Aymara		4771	Occitan	6149
Azerbaijani		4772	Oriya	6164
Bashkir		4847	Oromo (Afan)	6159
Basque		5167	Panjabi	6247
Bengali; Bangla		4860	Pashto; Pushto	6265
Bhutani		5072	Persian	5247
Bihari		4854	Polish [POL]	6258
Bislama		4855	Portuguese [POR]	6266
Breton		4864	Quechua	6367
Bulgarian		4853	Rhaeto-Romance	6459
Burmese		5971	Romanian [RUM]	6461
Byelorussian		4851	Russian [RUS]	6467
			S	
Cambodian	C-E	5759	Samoan	6559
Catalan		4947	Sangho	6553
Chinese [CHI]		7254	Sanskrit	6547
Corsican		4961	Scots Gaelic	5350
Croatian		5464	Serbian	6564
Czech [CZE]		4965	Serbo-Croatian	6554
Danish [DAN]		5047	Sesotho	6566
Dutch [DUT]		6058	Setswana	6660
English [ENG]		5160	Shona	6560
Esperanto		5161	Sindhi	6550
Estonian		5166	Sinhalese	6555
			Siswat	6565
Faroese	F-H	5261	Slovak	6557
Fiji		5256	Slovenian	6558
Finnish [FIN]		5255	Somali	6561
French [FRE]		5264	Spanish [SPA]	5165
Frisian		5271	Sundanese	6567
Galician		5358	Swahili	6569
Georgian		5747	Swedish [SWE]	6568
German [GER]		5051	T	
Greek [GRE]		5158	Tagalog	6658
Greenlandic		5758	Tajik	6653
Guarani		5360	Tamil	6647
Gujarati		5367	Tatar	6666
Hausa		5447	Telugu	6651
Hebrew		5569	Thai	6654
Hindi		5455	Tibetan	4861
Hungarian [HUN]		5467	Tigrinya	6655
			Tonga	6661
Icelandic [ICE]	I-K	5565	Tsonga	6665
Indonesian		5560	Turkish [TUR]	6664
Interlingua		5547	Turkmen	6657
Interlingue		5551	Twi	6669
Inupiak		5557	U-Z	
Irish [IRI]		5347	Ukrainian	6757
Italian [ITA]		5566	Urdu	6764
Japanese [JPN]		5647	Uzbek	6772
Javanese		5669	Vietnamese	6855
Kannada		5760	Volapuk	6861
Kashmiri		5765	Welsh	4971
Kazakh		5757	Wolof	6961
Kinyarwanda		6469	Xhosa	7054
Kirghiz		5771	Yiddish	5655
Kirundi		6460	Yoruba	7161
Korean [KOR]		5761	Zulu	7267
Kurdish		5767		
			L-N	
Laothian		5861		
Latin		5847		
Latvian; Lettish		5868		
Lingala		5860		
Lithuanian		5866		
Macedonian		5957		
Malagasy		5953		
Malay		5965		
Malayalam		5958		
Maltese		5966		
Maori		5955		

Note:

- If you choose a language that has a 3-letter abbreviation, the code will be displayed every time you change the audio or subtitle language setting above. If you choose any other language, ‘---’ will be displayed instead. (3-letter abbreviation is written in bracket.)

FAQ

Question	Answer
My remote control does not work. What should I do?	<ul style="list-style-type: none"> • Check the antenna or cable connection to the main unit. • Check the batteries of the remote control. • Check if there is an obstacle between the infrared sensor window and the remote control. • Test the signal output. If OK, then possible infrared sensor trouble. (Refer to "IR Signal Check" on page 54.) • Aim the remote control directly at the infrared sensor window on the front of the unit. • Reduce the distance to the unit. • Re-insert the batteries with their polarities (+/- signs) as indicated. • When there is an infrared-equipped device such as PC near this unit, it may interrupt the remote control signal of this unit. • Move the infrared-equipped device away from this unit, change the angle of the infrared sensor or turn off the infrared communication function.
How come the Initial setup appears every time I turn on this unit?	<ul style="list-style-type: none"> • Connect the RF coaxial cable to the unit directly and run the initial setup. • Make sure to complete the channel scan before turning off the unit.
Why I cannot watch some of TV programs?	<ul style="list-style-type: none"> • Make sure autoprogram has been completed. (Refer to "Autoprogram" on page 22.) • Autoprogram must be completed when you set up the unit for the first time or move it to a location where previously unavailable channels are broadcast. • The selected channel may not be broadcasting. • When autoprogram is interrupted and not completed, some channels will not be received. Make sure to complete. (Refer to "Autoprogram" on page 22.) • The selected channel cannot be viewed by the "Child Lock" setting. (Refer to "Child Lock" on page 30.) • The unit requires some kind of antenna input. An indoor antenna (rabbit ears), an external antenna, or an RF coaxial cable from your wall or cable receiver/satellite box needs to be plugged into the unit.
How come there is no image from the connected external devices?	<ul style="list-style-type: none"> • Check if the right input mode is selected by pressing [SOURCE] or using [CH + / -]. (Refer to "Switching Each Input Mode" on page 19.) • Check the antenna or cable connection to the unit.
Whenever I entered channel number, it changes automatically.	<ul style="list-style-type: none"> • Many digital channels have alternate channel numbers. The unit changes the numbers automatically to the ones signifying the broadcasting stations. These are the numbers used for analog broadcasts.
My disc cannot be played back. Is there any way I can play my disc?	<ul style="list-style-type: none"> • Clean the disc. • Ensure the disc is correctly inserted. • Check if the disc is defective by trying another disc. • Cancel the parental lock or change the control level. • Insert a correct disc that plays back on this unit. • Handle a disc with special care so that it does not have fingerprints, scratches or dusts on its surface.
Why are captions not displayed entirely? Or, captions are delayed behind the dialogue.	<ul style="list-style-type: none"> • Captions that are delayed a few seconds behind the actual dialogue are common for live broadcasts. Most captioning production companies can display a dialogue to maximum of 220 words per minute. If a dialogue exceeds that rate, selective editing is used to insure that the captions remain up-to date with the current TV screen dialogue.
How can I set the clock ?	<ul style="list-style-type: none"> • There is no clock function on this unit.

✓ Troubleshooting Guide

If the unit does not perform properly when operated as instructed in this manual, **check the following chart and all connections once before calling for service.**

Symptom	Remedy
No power	<ul style="list-style-type: none"> • Make sure the AC power cord is plugged in. • Make sure that the AC outlet supplies the proper voltage, plug another electrical appliance into the AC outlet. • If a power failure occurs, unplug the AC power cord for 30 minutes to allow the unit to reset itself.
Control button does not work.	<ul style="list-style-type: none"> • Press only one button at a time. Do NOT press more than one buttons at the same time.
Power is ON but no screen image.	<ul style="list-style-type: none"> • Check whether the connection of the antenna, cable receiver or satellite box is connected correctly. • Check whether all the cables to the unit are connected to the correct output jack of your device like BD/DVD recorder. • Make sure that the selected input mode is connected to the working input jack. • Check if your computer is NOT in sleep mode when the input mode of this unit is in PC mode. Tap any key on the keyboard to wake up your computer.
No picture or sound	<ul style="list-style-type: none"> • Check if the power is on. • Check if the right input mode is selected. • Check whether all the cables to the unit are connected to the correct output jack of your device like BD/DVD recorder. • View other TV channels. The problem might be limited to the broadcasting station. • Turn off the unit and wait for about 1 minute, then turn on the unit again. • Check whether the connection of the antenna, cable receiver or satellite box is connected correctly. • Make sure that the selected input mode is connected to the working input jack. • Check if your computer is NOT in sleep mode when the input mode of this unit is in PC mode. Tap any key on the keyboard to wake up your computer. • Make sure that the sound is not muted. Press [MUTE] so that the volume bar and current volume level will appear on the TV screen. • Make sure that the volume is NOT set to "0" or "Mute". If so, use [VOL + / -] to adjust the desired volume.
No color	<ul style="list-style-type: none"> • View other TV channels. The problem might be limited to the broadcasting station. • Adjust "Color" in the main menu.
Adjusted "PICTURE" or "SOUND" is not effective every time turn on the unit.	<ul style="list-style-type: none"> • You must set "Home" in "Location" (Refer to page 35). Otherwise, the settings you adjusted will not be memorized after you turn off the unit.
Sound OK, picture poor	<ul style="list-style-type: none"> • Electrical interference from nearby appliances may affect picture quality. • Adjust "Contrast" and "Brightness" in the main menu. • View other TV channels. The problem might be limited to the broadcasting station. • For the best picture quality, watch "high definition" wide screen programs. If the HD content is not available, watch "standard definition" programs instead.
Picture OK, sound poor	<ul style="list-style-type: none"> • View other TV channels. The problem might be limited to the broadcasting station. • Check if the audio cable is connected in correctly .
You see a distorted picture or hear an unusual sound.	<ul style="list-style-type: none"> • You may be getting interference from electrical appliances, automobiles, motorcycles or fluorescent lights. • Try moving the unit to another location to see if this is the cause of the problem.
Ghosts, lines or streaks in picture	<ul style="list-style-type: none"> • Electrical interference from nearby appliances may affect picture quality. • View other TV channels. The problem might be limited to the broadcasting station.
You see "noise" or "trash" on the screen.	<ul style="list-style-type: none"> • When the capabilities of the unit exceed the capabilities of the digital broadcasting, the signal will be increased to match the capabilities of the display of the unit. This may cause noise or trash.
Different color marks on the TV screen	<ul style="list-style-type: none"> • Move your unit away from nearby electric appliances. Turn off the unit and wait 30 minutes before turning it back on. • View other TV channels. The problem might be limited to the broadcasting station.

	Symptom	Remedy
T V	You switch to a different input and the volume.	<ul style="list-style-type: none"> This unit will memorize the volume level from the last time you adjusted it. If the volume of the sound from another device is higher or lower, then the loudness will change.
	You switch to a different input and the screen size changes.	<ul style="list-style-type: none"> This unit will memorize the viewing mode from the last time you used the particular input modes.
	The display image does not cover the entire screen.	<ul style="list-style-type: none"> If you are using the unit as a PC monitor, make sure that "Horizontal Position" and "Vertical Position" in "PC Settings" are set correctly. If you are watching TV or using the video, S-video, component video or HDMI with 480i input, press [FORMAT] repeatedly to switch various screen modes.
	Captions are displayed as a white box. No caption is displayed in the Closed Caption-supported program.	<ul style="list-style-type: none"> Interference from buildings or weather conditions may cause captioning to be incomplete. Broadcasting station may shorten the program to insert advertisement. The closed caption decoder cannot read the information of the shortened program.
	No caption is displayed when playing back a disc or a cassette tape containing captions.	<ul style="list-style-type: none"> The disc or cassette tape may be illegally copied, or the caption signal might not have been read during copying.
	Black box is displayed on the TV screen.	<ul style="list-style-type: none"> The text mode is selected for caption. Select "CC-1", "CC-2", "CC-3", "CC-4" or "Off".
D V D	Completely distorted picture or black/white picture with DVD.	<ul style="list-style-type: none"> Make sure the disc is compatible with the unit.
	Picture freezes momentarily during playback.	<ul style="list-style-type: none"> Check the disc for finger prints/scratches and clean with a soft cloth wiping from center to edge.
	Disc cannot be played.	<ul style="list-style-type: none"> Clean the disc. Ensure the disc is correctly inserted. Check if the disc is defective by trying another disc. Cancel the parental lock or change the control level. Insert a correct disc that plays on this unit. Handle a disc with special care so that it does not have fingerprints, scratches, or dusts on its surface.
	Buttons do not work or the unit stops responding.	<ul style="list-style-type: none"> To completely reset the unit, unplug the AC power cord from the power outlet for 5-10 seconds.
	The unit does not respond to some operating commands during playback.	<ul style="list-style-type: none"> Operations may not be permitted by the disc. Refer to the instructions of the disc.
	Angle does not switch.	<ul style="list-style-type: none"> The angle cannot be switched for DVD which do not contain multiple angles. In some cases multiple angles are only recorded for specific scenes.
	Playback does not start when the title is selected.	<ul style="list-style-type: none"> Check the "PARENTAL" setting.
The password for rating level has been forgotten.	<ul style="list-style-type: none"> Enter the default password "4737", then your forgotten password will be cleared. 	

Note:

- The LCD panel is manufactured to provide many years of useful life. Occasionally a few non active pixels may appear as a fixed point of blue, green or red. This is not to be considered a defect in the LCD screen.
- Some functions are not available in specific modes, but this is not a malfunction. Read the description in this manual for more details on correct operations.
- Some functions are prohibited on some discs.

✓ Glossary

ATSC

Acronym that stands for Advanced Television Systems Committee and the name of the digital broadcasting standards.

Aspect Ratio

The width of a TV screen relative to its height. Conventional TVs are 4:3 (in other words, the TV screen is almost square); widescreen models are 16:9 (the TV screen is almost twice as wide as its height).

CEC (Consumer Electronics Control)

This allows you to operate the linked functions between our brand devices with CEC feature and this unit.

Component Video

This is a video signal format that conveys each of 3 principal colors of light (red, blue and green) through different signal lines. This allows the viewers to experience picture colors as original as it is. There are several signal formats, including Y / Pb / Pr and Y / Cb / Cr.

Dolby Digital

The system developed by Dolby Laboratories to compress digital sound. It offers stereo sound (2ch) or multi-channel audio.

HDMI (High-Definition Multimedia Interface)

Interface that supports all uncompressed, digital audio/video formats including set-top box, BD/DVD recorder or digital television, over a single cable.

HDTV (High Definition TV)

Ultimate digital format that produces high resolution and high picture quality.

NTSC

Acronym that stands for National Television Systems Committee and the name of the current analog broadcasting standards.

Password / PIN Code

A stored 4-digit number that allows access to parental control features.

Region Code

Regions associate discs and players with particular areas of the world. This unit will only play back discs that have compatible region codes. You can find the region code of your unit by looking on the rear panel. Some discs are compatible with more than one region (or all regions).

SAP (Secondary Audio Program)

Second-audio channel delivered separately from main-audio channel. This audio channel is used as an alternate in bilingual broadcasting.

SDTV (Standard Definition TV)

Standard digital format that is similar to the NTSC picture quality.

S-video

Offers higher quality images by delivering each signal, color (c) and luminance (y) independently of each other through separate cables.

✓ Maintenance

Cabinet Cleaning

- Wipe the front panel and other exterior surfaces of the unit with a soft cloth immersed in lukewarm water and wrung dry.
- Never use a solvent or alcohol. Do not spray insecticide liquid near the unit. Such chemicals may cause damage and discoloration to the exposed surfaces.

Panel Cleaning

Wipe the panel of the unit with a soft cloth. Before cleaning the panel, disconnect the AC power cord.

Disc Handling

Handle the discs so that fingerprints and dust do not adhere to the surfaces of the discs.



- Always store the disc in its protective case when it is not used.
- To clean-off, use a soft cloth.
- Do not use a hard cloth since this will mar the disc.
- Wipe the disc in a straight line from center to edge.
- Never wipe with a circular motion.

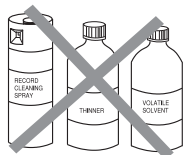

- Do not use detergent or abrasive cleaning agents.

Servicing

Should your unit become inoperative, do not try to correct the problem yourself. There are no user serviceable parts inside. Turn off the unit, unplug the AC power cord and call our toll free customer support line found on the cover of this manual to locate an authorized service center.

If the Laser Optical Pickup Unit is Dirty

If the unit still does not perform properly when it is operated, while referring to the relevant sections and to "Troubleshooting Guide" in this user manual, the laser optical pickup unit may be dirty. Consult your dealer or an Authorized Service Center for inspection and cleaning of the laser optical pickup unit.

IR Signal Check

If the remote control is not working properly, you can use an AM radio or digital camera (including a cellular phone with built-in camera) to see if it is sending out an infrared signal.

- With an AM radio: Tune the AM radio station to a non-broadcasting frequency. Point the remote control towards it, press any button and listen. If the sound from the radio flutters, it is receiving the remote control's infrared signal.

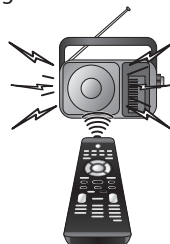

- With a digital camera (including built-in cell phone cameras): Point a digital camera towards the remote control. Press any button on the remote control and look through the digital camera. If the infrared light appears through the camera, the remote control is working.

✓ Cable Channel Designations

If you subscribe to cable TV, the channels are displayed as 1-135. Cable companies often designate channels with letters or letter-number combinations. Please check with your local cable company. The following is a chart of common cable channel designations.

CATV channel	5A	2	3	4	5	6	7	8	9	10	11	12	13	A	B	C	D	E	F	G	H
TV Display	1	2	3	4	5	6	7	8	9	10	11	12	13	14	15	16	17	18	19	20	21
CATV channel	I	J	K	L	M	N	O	P	Q	R	S	T	U	V	W	W+1	W+2	W+3	W+4	W+5	W+6
TV Display	22	23	24	25	26	27	28	29	30	31	32	33	34	35	36	37	38	39	40	41	42
CATV channel	W+7	W+8	W+9	W+10	W+11	W+12	W+13	W+14	W+15	W+16	W+17	W+18	W+19	W+20	W+21	W+22	W+23	W+24	W+25	W+26	W+27
TV Display	43	44	45	46	47	48	49	50	51	52	53	54	55	56	57	58	59	60	61	62	63
CATV channel	W+28	W+29	W+30	W+31	W+32	W+33	W+34	W+35	W+36	W+37	W+38	W+39	W+40	W+41	W+42	W+43	W+44	W+45	W+46	W+47	W+48
TV Display	64	65	66	67	68	69	70	71	72	73	74	75	76	77	78	79	80	81	82	83	84
CATV channel	W+49	W+50	W+51	W+52	W+53	W+54	W+55	W+56	W+57	W+58	A-5	A-4	A-3	A-2	A-1	W+59	W+60	W+61	W+62	W+63	W+64
TV Display	85	86	87	88	89	90	91	92	93	94	95	96	97	98	99	100	101	102	103	104	105
CATV channel	W+65	W+66	W+67	W+68	W+69	W+70	W+71	W+72	W+73	W+74	W+75	W+76	W+77	W+78	W+79	W+80	W+81	W+82	W+83	W+84	W+85
TV Display	106	107	108	109	110	111	112	113	114	115	116	117	118	119	120	121	122	123	124	125	126
CATV channel	W+86	W+87	W+88	W+89	W+90	W+91	W+92	W+93	W+94												
TV Display	127	128	129	130	131	132	133	134	135												

✓ General Specifications

TV

TV format: ATSC / NTSC-M TV standard

Closed caption system:

\$15.122/FCC (digital CC)

\$15.119/FCC (analog CC)

Channel coverage (ATSC/NTSC):

Terrestrial

VHF: 2~13 **UHF:** 14~69

CATV

2~13, A~W,
W+1~W+94 (analog W+1~W+84),
A-5~A-1, 5A

Tuning system:

Channel frequency synthesized tuning system

Channel access:

Direct access keyboard,
Programmable scan, and up/down

DVD

Discs (playback compatibility):

DVD video, DVD-RW/-R,

DVD+RW/+R, audio CD, CD-RW/-R

Frequency response:

DVD (linear sound): 20 Hz to 20 kHz (sample rate: 48 kHz)

20 Hz to 44 kHz (sample rate: 96 kHz)

CD:

20 Hz to 20 kHz

Signal-to-noise ratio (S/N ratio):

CD: 90 dB (JEITA)

Total distortion factor:

DVD: 1 kHz 0.007% (JEITA)

CD: 1 kHz 0.007% (JEITA)

✓ Electrical Specification

Sound Output: 10W, 8 Ω x 2

✓ Other Specifications

Terminals:

Antenna input: VHF/UHF/CATV

75Ω unbalanced (F-type)

Audio input: RCA jack (L/R) x 6

500mV rms

Video input: RCA jack x 1

1V p-p (75Ω)

S-video input: Mini DIN 4-pin jack x 1

Y: 1V p-p (75Ω)

C: 286mV p-p (75Ω)

Component video input:

RCA jack x 3

Y: 1V p-p (75Ω)

Pb: 700mV p-p (75Ω)

Pr: 700mV p-p (75Ω)

HDMI input: HDMI 19pin x 2

Coaxial digital audio output:

RCA jack x1

500mV p-p (75Ω)

Audio output: RCA jack (L/R) x 2

500mV rms

Remote control: Digital encoded infrared light system

Operating temperature:

41°F (5°C) to 104°F (40°C)

Power requirements:

120V~ AC +/- 10%, 60Hz +/- 0.5%

Power consumption (maximum):

160W

LCD: 32 inches class (31.5 inches measured diagonally)

Dimensions: <without stand> <with stand>

W: 30.0 inches (760mm) 30.0 inches (760mm)

H: 20.5 inches (519.3mm) 22.2 inches (563mm)

D: 5.1 inches (127.5mm) 9.4 inches (238mm)

Weight:

20.6 lbs. (9.3kg) 21.7 lbs. (9.8kg)

- Designs and specifications are subject to change without notice and without our legal obligation.
- If there is a discrepancy between languages, the default language will be English.

LIMITED WARRANTY NINETY (90) DAY LABOR / ONE (1) YEAR PARTS

WARRANTY COVERAGE:

This warranty obligation is limited to the terms as set forth below.

WHO IS COVERED:

This product warranty is issued to the original purchaser or the person receiving the product as a gift against defects in materials and workmanship as based on the date of original purchase ("Warranty Period") from an Authorized Dealer. The original sales receipt showing the product name and the purchase date from an authorized retailer is considered such proof.

WHAT IS COVERED:

This warranty covers new products if a defect in material or workmanship occurs and a valid claim is received within the Warranty Period. At its option, the company will either (1) repair the product at no charge, using new or refurbished replacement parts, or (2) exchange the product with a product that is new or which has been manufactured from new, or serviceable used parts and is at least functionally equivalent or most comparable to the original product in current inventory, or (3) refund the original purchase price of the product.

Replacement products or parts provided under this warranty are covered against defects in materials and workmanship from the date of the replacement or repair for ninety (90) days or for the remaining portion of the original product's warranty, whichever provides longer coverage for you. When a product or part is exchanged, any replacement item becomes your property and the replaced item becomes company property. When a refund is given, your product becomes company property.

Note: Any product sold and identified as refurbished or renewed carries a ninety (90) day limited warranty.

Replacement product can only be sent if all warranty requirements are met. Failure to follow all requirements can result in delay.

WHAT IS NOT COVERED - EXCLUSIONS AND LIMITATIONS:

This Limited Warranty applies only to new company manufactured products that can be identified by the trademark, trade name, or logo affixed to it. This Limited Warranty does not apply to any hardware product or any software, even if packaged or sold with the product, as manufacturers, suppliers, or publishers may provide a separate warranty for their own products packaged with the bundled product.

The company is not liable for any damage to or loss of any programs, data, or other information stored on any media contained within the product, or other additional product or part not covered by this warranty. Recovery or reinstallation of programs, data or other information is not covered under this Limited Warranty.

This warranty does not apply (a) to damage caused by accident, abuse, misuse, neglect, misapplication, or non-supplied product, (b) to damage caused by service performed by anyone other than company approved Authorized Service Location, (c) to a product

or a part that has been modified without written company permission, or (d) if any serial number has been removed or defaced, or (e) product, accessories or consumables sold "AS IS" without warranty of any kind by including refurbished product sold "AS IS" by some retailers.

This Limited Warranty does not cover:

- Shipping charges to return defective product.
- Labor charges for installation or setup of the product, adjustment of customer controls on the product, and installation or repair of antenna/signal source systems outside of the product.
- Product repair and/or part replacement because of improper installation or maintenance, connections to improper voltage supply, power line surge, lightning damage, retained images or screen markings resulting from viewing fixed stationary content for extended periods, product cosmetic appearance items due to normal wear and tear, unauthorized repair or other cause not within the control of the company.
- Damage or claims for products not being available for use, or for lost data or lost software.
- Damage from mishandled shipments or transit accidents when returning product.
- A product that requires modification or adaptation to enable it to operate in any country other than the country for which it was designed, manufactured, approved and/or authorized, or repair of products damaged by these modifications.
- A product used for commercial or institutional purposes (including but not limited to rental purposes).
- Product lost in shipment and no signature verification receipt can be provided.
- Failure to operate per Owner's Manual.

TO OBTAIN ASSISTANCE...

Contact the Customer Care Center at:
1-866-341-3738

REPAIR OR REPLACEMENT AS PROVIDED UNDER THIS WARRANTY IS THE EXCLUSIVE REMEDY FOR THE CONSUMER, WITH THE ISSUING COMPANY NOT LIABLE FOR ANY INCIDENTAL OR CONSEQUENTIAL DAMAGES FOR BREACH OF ANY EXPRESS OR IMPLIED WARRANTY ON THIS PRODUCT. EXCEPT TO THE EXTENT PROHIBITED BY APPLICABLE LAW, ANY IMPLIED WARRANTY OF MERCHANTABILITY OR FITNESS FOR A PARTICULAR PURPOSE ON THIS PRODUCT IS LIMITED IN DURATION TO THE DURATION OF THIS WARRANTY.

Some states do not allow the exclusions or limitation of incidental or consequential damages, or allow limitations on how long an implied warranty lasts, so the above limitations or exclusions may not apply to you.

This warranty gives you specific legal rights. You may have other rights which vary from state/province to state/province.

FUNAI CORPORATION, Inc. 19900 Van Ness Avenue, Torrance, CA 90501